

Notti italiane/

ITALIAN NIGHTS

.....
BEDS / STORAGE UNITS



Alf DaFre®



Alf DaFre®

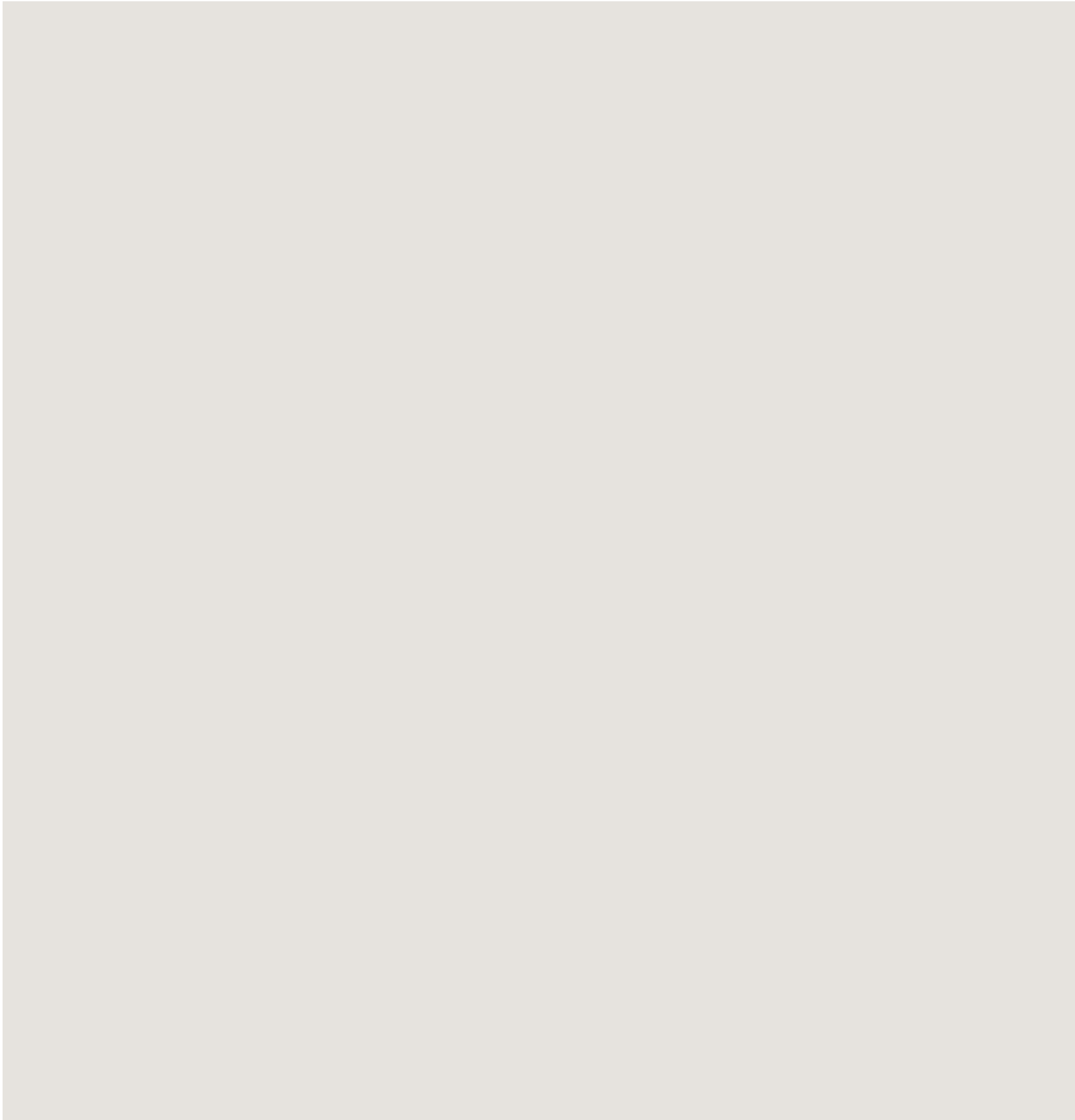
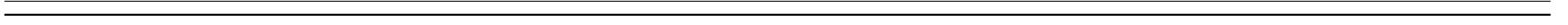

Il posto più riposante e personale della casa.

Il letto non è un semplice complemento d'arredo, ma un elemento fondamentale dell'habitat domestico. Con piattaforma, con contenitore, con testiera componibile: ALF vi propone una grande scelta di letti per tutti i desideri, gli spazi e gli stili di vita e in più, tanti contenitori, accessori e armadi per creare il vostro ambiente notte ideale.



The most relaxing and personal space in the home.

A bed is not simply a piece of furniture, it is a fundamental part of your living space.

Platforms, storage units and modular headboards: ALF offers a wide array of beds to suit your spaces, lifestyles and personal preferences. What's more, it offers storage solutions, accessories and wardrobes to create your ideal bedroom space.

El espacio más relajante y personal del hogar.

La cama no es un mero complemento de mobiliario, sino un elemento fundamental del hábitat doméstico.

Con armazón, con contenedor, con cabecera componible: ALF te ofrece una amplia gama de camas para todos los gustos, espacios y estilos de vida, además de un sinfín de contenedores, accesorios y armarios para crear tu dormitorio ideal.

L'endroit le plus reposant et personnel de la maison.

Le lit n'est pas un simple complément de décoration, mais un élément fondamental de l'habitat domestique.

Avec cadre, avec coffre, avec tête de lit modulable : ALF vous propose un grand choix de lits pour tous les désirs, les espaces et les styles de vie et en plus, beaucoup de modules, accessoires et armoires pour créer votre espace nuit idéal.

Der persönlichste Ort in unserem Zuhause, an dem wir uns entspannen.

Ein Bett ist mehr als ein einfacher Einrichtungsgegenstand. Unser Bett ist ein fundamentales Element in unserem Zuhause.

Mit Rahmen, Bettkasten und kombinierbarem Kopfteil: Alf bietet Ihnen ein breites Angebot, dass alle Ihre Wünsche erfüllt. Unsere Betten passen in jeden Raum und zu jedem Lebensstil. Wählen Sie unter unseren Anbauelementen, dem Zubehör und unseren Schränken die ideale Einrichtung für Ihren Schlafbereich.

Самое располагающее к отдыху и интимное место в доме.

Кровать - это не просто предмет мебели, а фундаментальный элемент домашней обстановки.

С рамой, с контейнером, со сборной головной спинкой: ALF предлагает широкий выбор кроватей, удовлетворяющих любым желаниям, подходящих для любого пространства и любого стиля жизни, а кроме того - множество контейнеров, аксессуаров и шкафов для создания идеальной спальной обстановки.

Diversi modi di scegliere un letto

Different ways of choosing a bed

LETTI CON PIATTAFORMA: IL PIACERE DELLA FUNZIONALITÀ

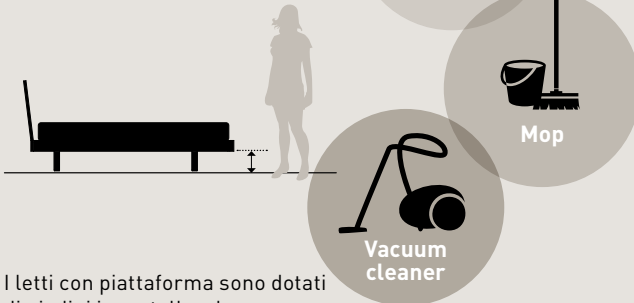

I letti con piattaforma sono dotati di piedini in metallo o legno massello, con un'altezza studiata per permettere un'agevole e completa pulizia del pavimento con tutti i sistemi: dal panno antipolvere, all'aspirapolvere, al robot aspirapolvere. Inoltre i piedini contribuiscono a caratterizzare l'estetica del letto, a seconda della loro forma e finitura.

Beds with a platform: pleasantly functional. The beds with platforms feature metal or solid-wood feet. They are built at a height designed to allow for full and thorough cleaning of the floor using any system, from a dust cloth to a hoover or hoover robot. The feet also add character, as they come in different shapes and finishes.

Camas con plataforma: el placer de la funcionalidad. Las camas con plataforma tienen patas de metal o madera maciza, con una altura estudiada para facilitar la limpieza a fondo del suelo con cualquier sistema: desde el paño antipolvo hasta la aspiradora, pasando por el robot aspirador. Además, las patas ayudan a definir la estética de la cama, según su forma y acabado

Lits avec encadrement : le plaisir de la fonctionnalité. Les lits avec encadrement sont équipés de pieds en métal ou en bois massif, avec une hauteur conçue afin de permettre un

nettoyage facile et complet du sol avec tous les systèmes : du chiffon anti-poussière, à l'aspirateur, au robot aspirateur. Par ailleurs, les pieds contribuent à caractériser l'esthétique du lit, selon leur forme et finition.

Betten mit Liegefläche: Funktionalität genießen. Die Betten mit Liegefläche verfügen über Füße aus Metall oder Massivholz. Die Höhe der Füße ermöglicht es Ihnen, bequem unter dem Bett sauber zu machen, unabhängig welches Reinigungssystem Sie wählen: mit einem Bodenwischer mit Staubtuch, einem Staubsauger oder einem Saugroboter. Darüber hinaus sind die Bettfüße ein ästhetisches Element der Einrichtung, und geben je nach ihrer Form und Ausführung Ihrem Bett einen besonderen Charakter.

Кровати на платформе: удовольствие функциональности. Кровати на платформе комплектуются ножками из металла или цельного дерева, с высотой, специально рассчитанной для того, чтобы можно было легко и полностью очистить пол с помощью любых систем: от тряпки для уборки пыли до пылесоса и робота-пылесоса. Кроме того, ножки способствуют приданию кровати индивидуального эстетического стиля - в зависимости от их формы и отделки.

LETTI SOMMIER: IL SENSO DELLA BELLEZZA E DELLA MORBIDEZZA



I letti sommier sono realizzati con base e testiera imbottite e rivestite. Una scelta adatta a chi vuole provare una sensazione morbida e avvolgente, ed in più scegliere in una gamma completa di rivestimenti e colori: tessuti raffinatamente di moda o piacevolmente grezzi, pelle di alta qualità o ecopelle in tante tonalità diverse. Anche la sartorialità della realizzazione, aggiunge un valore speciale al letto.

Sofa beds: it's all about softness and the look. The sofa beds are made from a base and a padded, upholstered headboard. This makes them ideal for those who are looking for a soft, enveloping feel and want to choose from a full range of colours and upholstery: from elegantly fashionable or raw-appeal fabrics to high-quality or ecological leather in a wide range of different shades. The tailored finishings also bring a special added value to the bed.

Camas con canapé: una sensación de belleza y suavidad. Las camas con canapé están realizadas con base y cabecera tapizadas y revestidas. La opción perfecta para quienes desean experimentar una sensación mullida y acogedora, aparte de escoger entre una completa gama de revestimientos y colores: elegantes tejidos de tendencia o de agradable textura en bruto, pieles de alta calidad o eco-piel en un gran abanico de tonos. El carácter artesanal de la fabricación también aporta un valor añadido a la cama.

Lits sommier: le sens de la beauté et du moelleux.

Les lits sommier sont réalisés avec base et tête de lit rembourrées et revêtues. Un choix adapté à ceux qui souhaitent essayer une sensation moelleuse et enveloppante et, en plus, choisir dans une gamme complète de revêtements et coloris : tissus raffinés et à la mode ou agréablement bruts, cuir de haute qualité ou éco-cuir en de nombreuses tonalités. Le travail de couturier de la réalisation ajoute également une valeur spéciale au lit.

Boxspringbetten – schön und weich. Boxspringbetten bestehen aus einem gepolsterten Unterteil und Kopfteil mit Bezug. Sie eignen sich besonders für alle, die es gerne weich und gemütlich haben. Unser breites Sortiment von Bezügen und Farben bietet feine oder grobe modische Stoffe, Qualitätsleder oder Kunstleder in zahlreichen Farben. Die qualitativ hochwertige Ausführung der Nähte und Schnitte gibt ihrem Bett einen ästhetischen Mehrwert.

Кровати сомье: чувство красоты и мягкости. Кровати сомье имеют мягкое набивное и облицованное основание и головную спинку. Решение, подходящее для тех, кто хочет испытать ощущение обволакивающей мягкости и выбрать наиболее подходящий для себя вариант среди широчайшего ассортимента вариантов отделок и цветов: ткани с модной изысканностью или приятной грубоватостью, высококачественная кожа и экокожа самых разных цветов. И наконец, особую ценность кровати придает мастерский характер ее изготовления.

LETTI CON CONTENITORE: UNO SPAZIO PER TUTTE LE STAGIONI

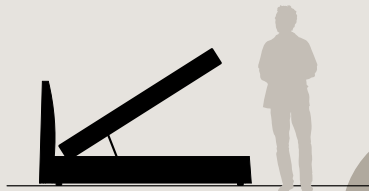

Oltre ad essere imbottiti e rivestiti, i sommier con contenitore permettono di riporre biancheria, piumini e altri oggetti, sempre a portata di mano ed al riparo dalla polvere. Grazie all'apposito meccanismo, il sollevamento della rete è facile e sicuro. Una soluzione ideale per chi vuole risparmiare spazio e guadagnare in comodità, senza rinunciare all'estetica.

Beds with storage units: a space for all seasons.

In addition to being padded and upholstered, these sofa beds with storage units provide a handy space for underwear, quilts or other items, keeping them dust-free. Thanks to the specific mechanism used, the spring system can be easily and safely lifted, making these ideal for those who are in search of a space-saving solution that is both practical and aesthetically pleasing.

Camas con contenedor: un espacio para todas las temporadas. Además de estar tapizados y revestidos, los canapés con contenedor permiten guardar ropa, almohadas y demás objetos, siempre al alcance de la mano y protegidos del polvo. Gracias a su mecanismo específico, levantar el somier resulta fácil y seguro. Una solución ideal para ahorrar espacio y ganar en comodidad, sin renunciar a la estética.

Lits avec coffre : un espace pour toutes les saisons. Outre à être rembourrés et revêtus, les sommiers avec coffre permettent

de ranger la lingerie, les duvets et autres objets, toujours à portée de main et à l'abri de la poussière. Grâce au mécanisme prévu à cet effet, le levage du sommier est facile et sûr. Une solution parfaite pour ceux qui souhaitent économiser de l'espace et gagner en commodité, sans renoncer à l'esthétique.

Betten mit Bettkasten: Mehr Platz für alle Jahreszeiten. Boxspringbetten mit Bettkasten bieten Ihnen neben der weichen Polsterung und den ästhetischen Bezügen die Möglichkeit, Wäsche, Bettdecken und anderes immer gut erreichbar und geschützt vor Staub zu verstauen. Der Hebe Mechanismus sorgt dafür, dass der Lattenrost einfach und sicher angehoben werden kann. Eine ideale Lösung für alle, die Platz sparen und mehr Bequemlichkeit wollen, ohne auf Ästhetik zu verzichten.

Кровати с контейнером: пространство для любого времени года. Помимо мягкой обивки и облицовки, сомы с контейнерами позволяют хранить в них бельё, одеяла и другие вещи, которые будут всегда под рукой и в то же время спрятаны от пыли. Благодаря специальному механизму, подъем сетки прост и надежен. Идеальное решение для тех, кто хочет сэкономить пространство и выиграть в удобстве, не отказываясь при этом от эстетической составляющей кровати.

LETTI CON BOISERIE COMPONIBILE: PER ARREDARE IN TOTALE LIBERTÀ

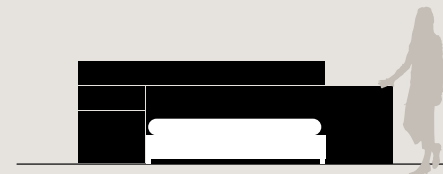

Questa soluzione permette di integrare il letto in un vero e proprio sistema di boiserie componibile per la parete, attrezzabile a piacere con mensole, contenitori ed anche con un sistema di illuminazione che crea un'emozionante atmosfera. È possibile arredare e personalizzare lo spazio notte, scegliendo fra diverse finiture: dai colori laccati opachi o lucidi, al legno in molteplici essenze e tonalità.

Beds with modular wooden panelling: to furnish in total freedom. This solution allows you to integrate the bed into a real modular, wall panelling composition which can be accessorised to taste with shelves, storage units and a lighting system to create an atmospheric mood. The bedroom space can be furnished and personalised with different finishes, from matt or high-gloss lacquered colours to different wood grains and shades.

Camas con boiserie componible: para amueblar con total libertad. Esta solución permite integrar la cama en un auténtico sistema de boiserie componible para la pared, libremente equipable con estantes, contenedores e incluso un sistema de iluminación que crea una sugestiva atmósfera. Se puede amueblar y personalizar el dormitorio eligiendo entre diversos acabados: desde los colores lacados mate o brillantes hasta la madera, disponible en distintas variedades y tonalidades

Lits avec boiserie modulable : pour décorer en toute liberté. Cette solution permet d'intégrer le lit dans un véritable système de boiserie modulable pour la paroi, pouvant être équipée à son gré avec des étagères, des modules et également avec un système d'éclairage qui crée une émouvante

atmosphère. Il est possible de décorer et personnaliser l'espace nuit, en choisissant parmi différentes finitions : des laqués mats ou brillants, au bois en de multiples versions de bois et de tonalités.

Betten mit kombinierbarer Wandverkleidung: Mehr Freiheit bei der Einrichtung. Mit dieser Lösung kann das Bett in eine Wandverkleidung integriert werden, die nach Belieben mit Borden und Anbauelementen ausgestattet werden kann. Ein entsprechendes Beleuchtungssystem sorgt für eine raffinierte Atmosphäre. Mit unseren Ausführungen, die Ihnen zur Wahl stehen, können Sie Ihren Schlafbereich Ihrem persönlichen Geschmack anpassen: Das Angebot reicht dabei von matten oder glänzenden Farblackarten in unterschiedlichen Farbtönen.

Кровати со сборной системой буазери: для меблировки в полной свободе. Это решение позволяет интегрировать кровать в настоящую сборную систему буазери для стенки, которая может быть оборудована по желанию полками, ящиками и даже системой освещения, создающей волнующую атмосферу. Можно оборудовать и оформить спальню согласно индивидуальным пожеланиям, выбрав различные отделки: от крашеных матовых или блестящих цветов до дерева самых разнообразных пород и тоналностей.

CONTENITORI SINGOLI

Single storage units

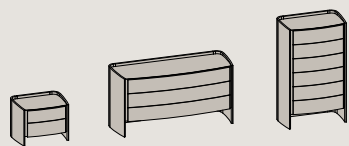

Adj
pag. 12



Linea
pag. 104

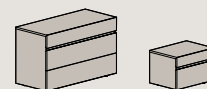

Twice
pag. 154

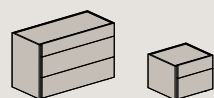

Da-do system
pag. 32



Rim
pag. 116

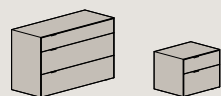

Fil
pag. 64

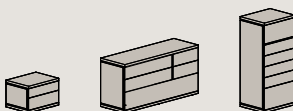

Segno
pag. 124

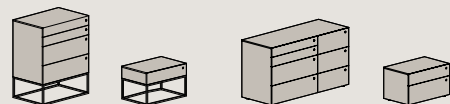

Hobby
pag. 90

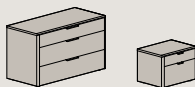

Timeless
pag. 138

Cosa ti serve per contenere ed arredare?

Cosa ti serve per contenere ed arredare?

CONTENITORI COMPONIBILI

Modular storage units

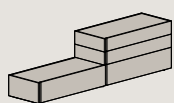

Da-do system
pag. 32

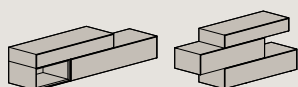

Fil
pag. 64

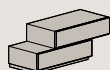

Linea
pag. 104

COMPLEMENTI AGGREGABILI

Combinable complements

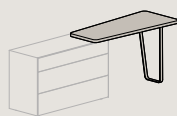

Da-do/Fil + scrivitoio
orientabile Orbit
Da-Do/Fil + Orbit
adjustable desk
pag. 44 / 75

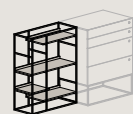

Hobby + Up
pag. 97

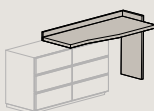
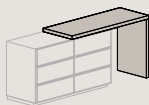
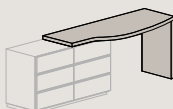

Linea + scrivitoi fissi
Linea + fixed desks
pag. 108

SPECCHIERE

Mirrors



Enya
pag. 190

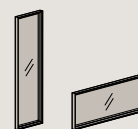

Fil
pag. 192



Haiku
pag. 194



Haiku Servomuto



Quadrata
pag. 196



Rettangolare

PIATTAFORMA

Platform

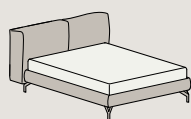

California
pag. 212



Da-Do testiera imbottita
Da-Do upholstered
headboard
pag. 227

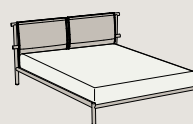

Jetty
pag. 238

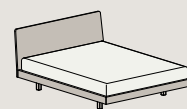

Teo
pag. 294

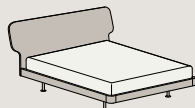

Clipper
pag. 218

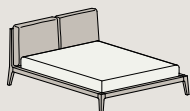

Dorian con cuscini
Dorian with cushions
pag. 230



Jordy
pag. 246

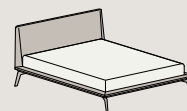

Xilo
pag. 298

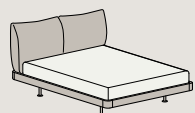

Cloud
pag. 222

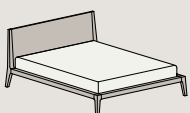

Dorian
pag. 232

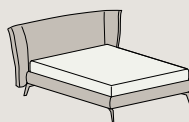

Morrison
pag. 263

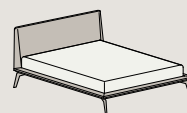

Xilo cuoio
pag. 300

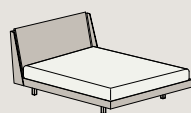

Da-Do
pag. 226

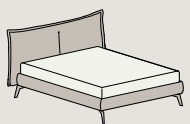

Francis
pag. 234

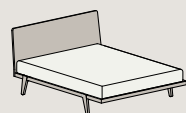

Teo
pag. 292

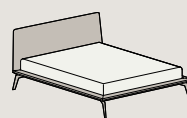

Xilo testiera imbottita
Xilo upholstered
headboard
pag. 302

Che letto soddisfa i tuoi sogni e le tue esigenze?

Which bed matches your needs and preferences?

SOMMIER

Sofa bed

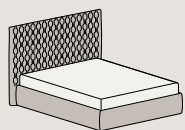

Allen
pag. 200

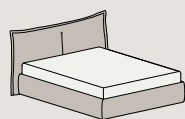

Francis
pag. 234

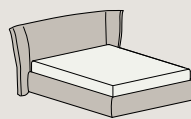

Morrison
pag. 268

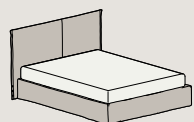

Aren
pag. 204



Jetty
pag. 243

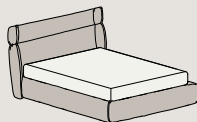

Oregon
pag. 270

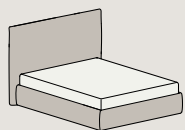

Aston
pag. 208

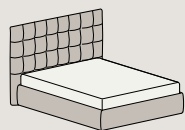

Leonard
pag. 254

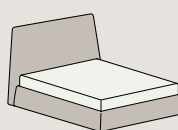

Ralph
pag. 275



California
pag. 216



Milano
pag. 258

COMPONIBILE

Modular

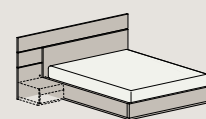

Skip
pag. 280

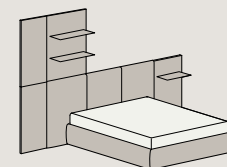

Suite system
pag. 284





Adj

ADJ

.....

gruppo notte / storage units







Adj comodino /night stand	L60 P46 H46
Adj comò /dresser	L140 P54 H76
Adj settimanale /6 drw chest	L74,2 P46 H123
Ralph letto /bed	L173,5 P224 H112,6
Ceppo tavolino /occasional table	L30 P30 H47



ADJ
/
RALPH
morbide
curve e
delicate
inclinazioni

Soft curves and gradual
inclines

Curvas suaves y delicadas
inclinaciones

Courbes douces et
inclinaisons délicates

Geschwungen weiche Linien
und leicht schräge Flächen

Мягкие линии и деликатный
наклон



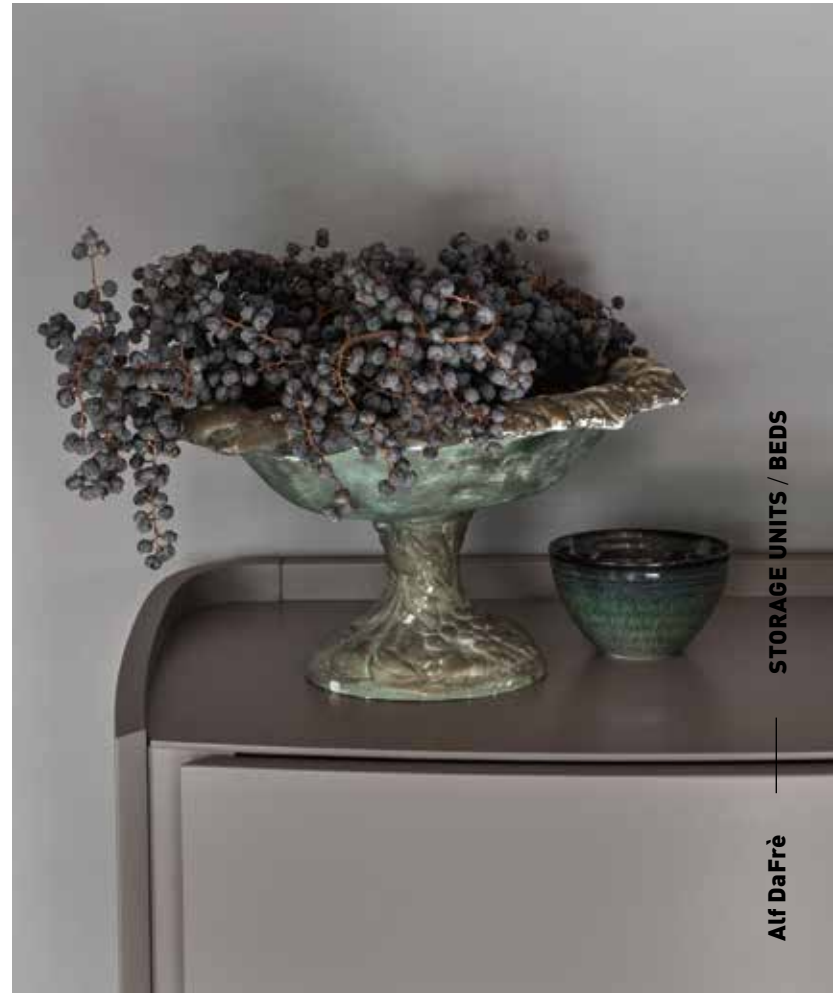







Adj comodino /night stand	L60 P46 H46
Adj comò /dresser	L140 P54 H76
Adj settimanale /6 drw chest	L74,2 P46 H123
Xilo letto /bed	L174,5 P216 H95,2
Odette poltrona /armchair	L60,3 P87,8 H87

2173
Martensb. Noremb. 1917
ora 12 cont. 1917
entra no. a longu
labato 2 Noremb. 1918
Lanone in a. n. b. v. v.
1917 12. a. n. v. v. f. d. v. v.
Lanone in a. n. b. v. v.













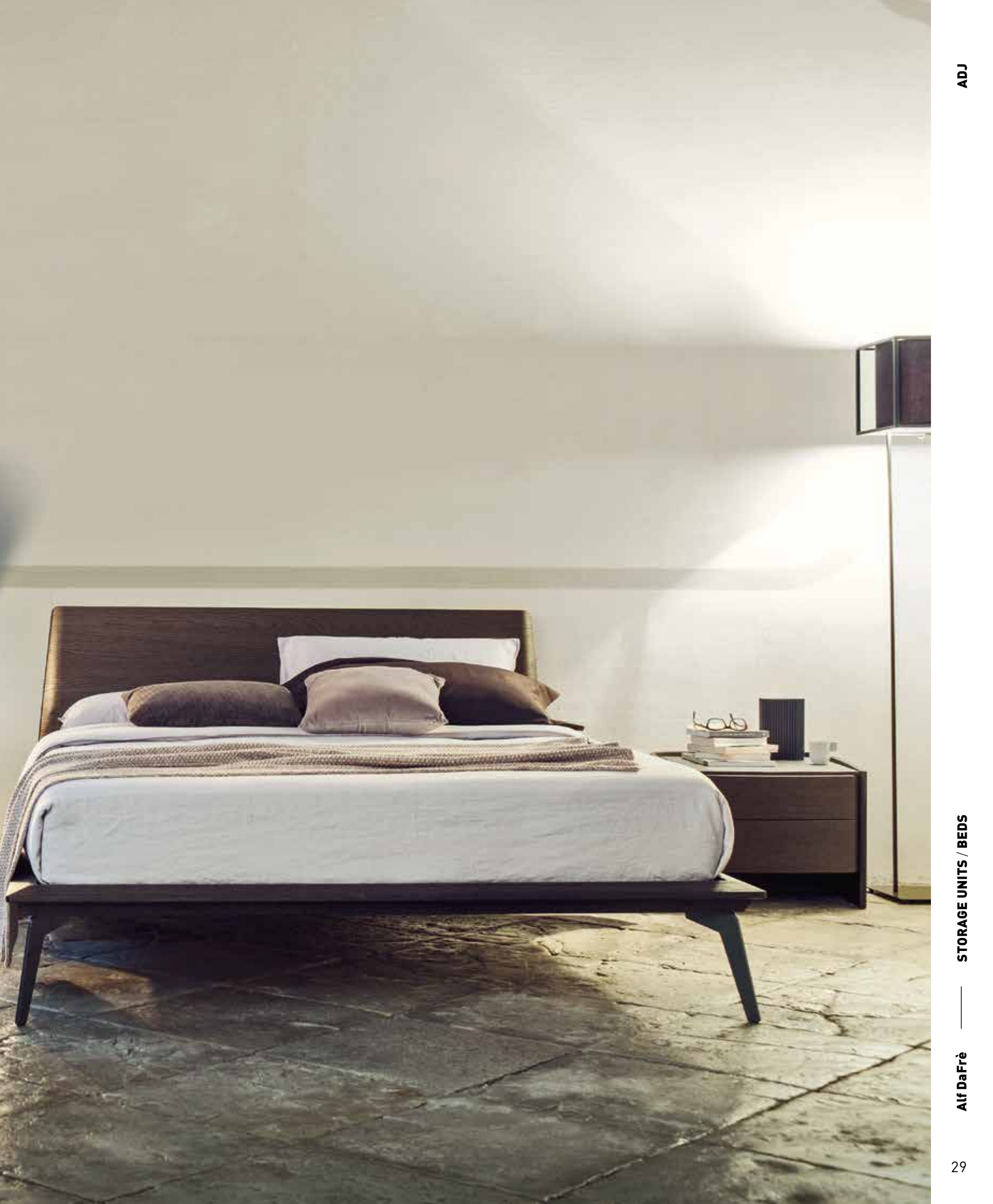



Le linee curve danno grande carattere a questo gruppo letto che si distingue anche per l'originale taglio inclinato della parte superiore. In questo modo il top diventa anche un pratico portaoggetti delimitato dalle linee del mobile stesso.

The curved lines add real character to this bed composition, which also features an original slanted angle on top. This turns the top into an extra practical storage and display surface, framed by the structure of the unit itself.

Las líneas curvas infunden un marcado carácter a este conjunto de dormitorio, que se distingue además por el original corte inclinado de la parte superior. De esta manera, la encimera sirve también de práctico portaobjetos delimitado por las formas del propio mueble.

Les lignes arrondies donnent beaucoup de caractère à ce groupe lit qui se distingue également pour l'originale coupe inclinée de la partie supérieure. De cette manière, le dessus devient également un pratique porte-objets délimité par les lignes du meuble.

Die geschwungenen Linien geben dieser Bettgruppe einen ganz besonderen Charakter, die durch den angestrebten Kopfteil eine originelle Note erhält. Dadurch erhält man eine praktische Ablage, die durch die sanften Linien des Bettes begrenzt ist.

Изогнутые линии придают особый характер этой спальне, также характеризующейся наклонным вырезом в верхней части. Таким образом столешница становится практичным вещевым отсеком, ограниченным линиями самого элемента мебели.

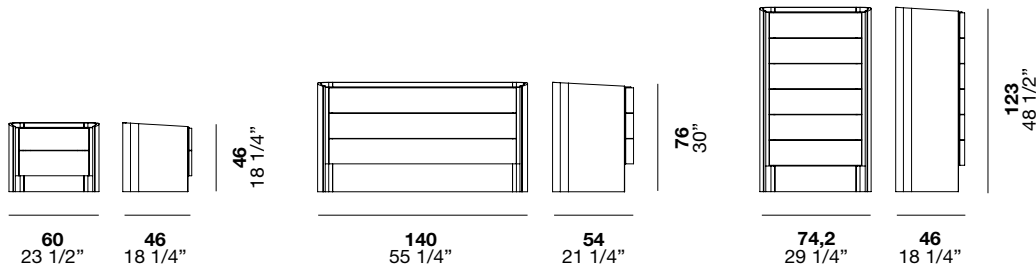



Da-Do

DA-DO

.....
gruppo notte / storage units





Da-do system comò /dresser L148 P53 H74,4 |







DA-DO SYSTEM

XILO seduzioni di tessuto, legno e metallo

Fabric, wood and metal temptations

Seduciones de tejido, madera y metal

Séductions de tissu, bois et métal

Verführerisches Spiel mit Stoff, Holz und Metall

Обольстительность ткани, дерева и металла

Xilo letto /bed	L174,5 P216 H95,2
Da-do system comodino /night stand	L60 P45 H37,1
Denny pouf /pouf	L85 P85 H37



Teo letto /bed **L169 P214 H92**

Da-do system moduli a sx /lsf units **L90 P53 H57,6**

Da-do system composizione comò /dresser composition **L238 P53 H48,8**







DA-DO
SYSTEM
/
TEO
eleganza
curata
nei
particolari

Elegance down to the details

Elegancia cuidada en los detalles

Élégance soignée dans les détails

Eleganz bis ins kleinste Detail

Элегантность, проявляющаяся в деталях





Da-Do letto / bed.....	L173 P214,7 H93,7
Da-do system moduli a sx /lsf units	L90 P45 H29,8 / L60 P45 H37,1
Da-do system composizione comò /dresser composition	L148 P53 H74,4
Haiku servomuto /clothing rack	L50 P32 H120,3



.....
Da-do system composizione scrittoio/desk composition ... L228 P60 H78,5

Wok box tavolino /occasional table L35 P35 H43

Karina sedia /chair L45,5 P53 H81





Aren letto /bed	L146 P213 H106
Da-do system moduli a sx /lsf units	L60 P45 H47,1
Domino* composizione /composition.....	L96 P34,7 H256
Da-do system composizione scrittoio/desk composition	L228 P60 H78,5
Wok box tavolino /occasional table	L35 P35 H43
Karina * sedia /chair.....	L45,5 P53 H81

*Per questo articolo vedi "Complementi" - Il senso dei dettagli
 *For this article see "Complements" - A sense of detail





DA-DO
SYSTEM
/
CALIFORNIA
il letto
al centro
dell'abitare

The bed is at the heart of
your living space

La cama como núcleo del
hogar

Le lit au centre de
l'habitation

Das Bett als Mittelpunkt des
Zuhauses

Кровать в центре жилого
пространства



.....
California letto /bed	L177 P230 H75
Da-do system composizione letto /bed composition	L325,9 P98 H47,1
Da-do system composizione comò /dresser composition.....	L238 P45 H35,1
Denny pouf /pouf	L55 P55 H42









.....
Da-do system composizione comò /dresser composition L238 P45 H35,1
Denny pouf /pouf L55 P55 H42



DA-DO SYSTEM

Soft, generous shapes

Volúmenes mullidos y generosos

Volumes moelleux et généreux

Großzügige und weiche Formen

Мягкие и обширные объемы

MILANO volumi morbidi e generosi



Milano letto /bed	L184 P234,8 H94,3
Da-do system moduli a sx /lsf units.....	L120 P45 H37,1
Da-do system moduli a dx /rsf units.....	L60 P45 H37,1
Up libreria /bookcase	L219,6 P33,2 H99,8



Suite system letto /bed	L360 P210 H224,4
Da-do system moduli a dx /rsf units	L90 P45 H47,1
Wok box tavolino /occasional table	L35 P35 H43
Da-do system composizione comò/dresser composition	L228 P45 H54,4







SUITE SYSTEM /DA-DO SYSTEM il tessuto diventa arredo

Fabric becomes furniture
El tejido que amuebla
Le tissu devient décoration
Wenn Stoff zur Einrichtung wird
Ткань создает обстановку





.....
Dorian letto/bed L180 P228,4 H96,6
Rim comodino /night stand L40 P40 H52
Da-do system composizione comò /dresser composition L90 P45 H101,7
.....



Da-do system

design R.D.A.

Da-Do è un gruppo letto componibile caratterizzato dalla grande modularità e versatilità. Rigoroso e lineare può abbinare due finiture, una per l'esterno e una per top e gola che funge da presa per l'apertura. Semplicemente sovrapponendo i moduli o fissandoli a parete, Da-Do offre infinite possibilità compositive per sfruttare al meglio lo spazio e personalizzare in modo unico l'ambiente notte.

Da-Do is a highly versatile, modular bed unit. Its clean, linear look features two finishes, one for the exterior and one for the top and groove, which also serves as a handle grip. By stacking or mounting the units on the wall, Da-Do offers an infinite number of possible compositions to make the best use of your space and personalise the bedroom in a truly unique way.

Da-Do es un conjunto de dormitorio que se caracteriza por su gran modularidad y versatilidad. Rigoroso y lineal, puede combinar dos acabados, uno para el exterior y otro para la encimera y la ranura que sirve como asidero de apertura. Simplemente apilando los módulos o fijándolos a la pared, Da-Do ofrece infinitas posibilidades de composición para aprovechar al máximo el espacio y personalizar el dormitorio con un toque único.

Da-Do est un groupe lit pouvant être composé et caractérisé par sa grande modularité et versatilité. Rigoureux et linéaire, il peut être associé à deux finitions, une pour l'extérieur et une pour le dessus et la gorge qui sert de prise pour l'ouverture. En superposant tout simplement les modules ou en les fixant au mur, Da-Do offre d'infinies possibilités de composition pour exploiter au mieux l'espace et personnaliser de façon unique l'espace nuit.

Da-Do ist eine kombinierbarer Bettgruppe, die sich durch ihre große Modularität und Flexibilität auszeichnet. Der strenge und lineare Stil bietet die Möglichkeit, zwei Ausführungen miteinander zu kombinieren: eine für die Außenseite und eine für die Oberseite und die Kehlleiste, die als Griff dient. Die Module können einfach übereinander oder an der Wand montiert werden. So bietet Da-Do unendliche Kombinationsmöglichkeiten, um den Raum bestmöglich zu nutzen und den Wohnbereich auf einzigartige Weise personalisieren.

Da-Do - сборный спальный блок, отличающийся высоким уровнем модульности и гибкости. В строгом стиле с прямыми линиями он может сочетать два варианта отделки: одна - для наружных поверхностей, а другая - для топов и паза, который играет роль захвата для открытия. За счет простой установки отдельных модулей один на другой или закрепления их на стене, Da-Do предлагает бесконечные композиционные возможности для оптимального использования пространства и уникальной индивидуализации спальной обстановки.

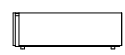

45 / 60 / 90 / 120
17 3/4" 23 1/2"
35 1/2" 47 1/4"

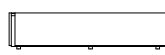

148
58 1/4"

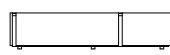

133 / 148 / 178
52 1/4" 58 1/4" 70"

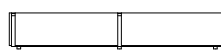

178 / 238
70" 93 3/4"



45 / 53
17 3/4" 20 3/4"

19,6 / 29,6
7 3/4" 11 3/4"

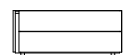

45 / 60 / 90 / 120
17 3/4" 23 1/2"
35 1/2" 47 1/4"



45 / 53
17 3/4" 20 3/4"

37,1
14 1/2"

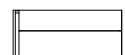

45 / 60 / 90 / 120
17 3/4" 23 1/2"
35 1/2" 47 1/4"

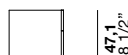

45 / 53
17 3/4" 20 3/4"

47,1
18 1/2"

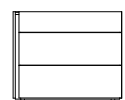

90 / 120
35 1/2" 47 1/4"

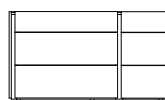

133 / 148
52 1/4" 58 1/4"



53
20 3/4"

74,4
29 1/4"

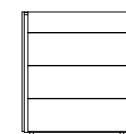

90
35 1/2"

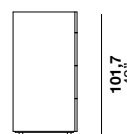

53
20 3/4"

101,7
40"

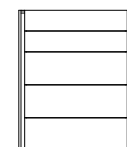

45 / 60 / 90
17 3/4" 23 1/2" 35 1/2"

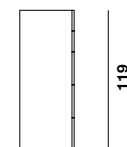

45
17 3/4"

119
46 3/4"



Fil

FIL
.....
gruppo notte / storage units



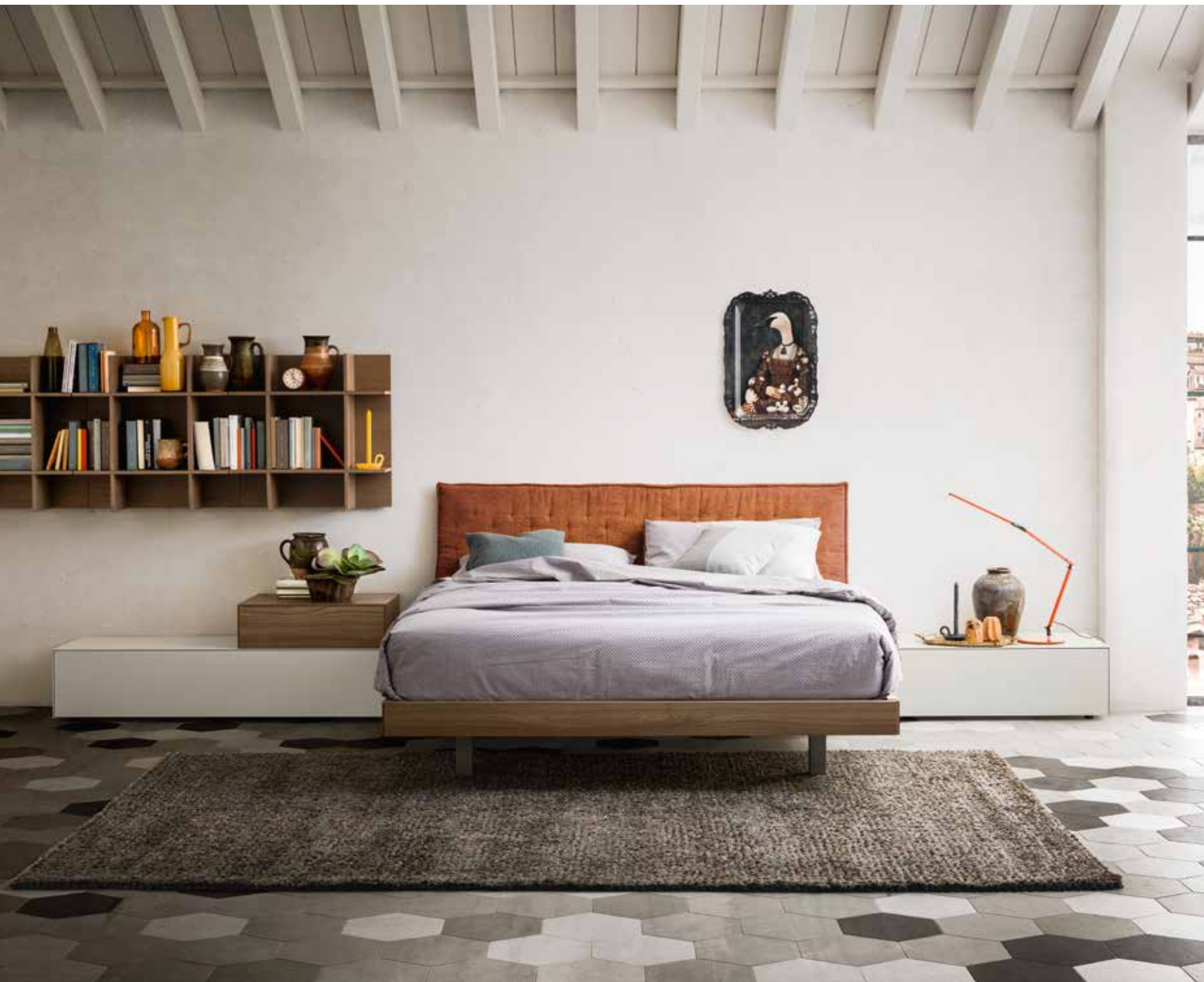

Teo letto /bed	L177 P217 H92	Fil moduli a sx /lsf units	L135 P48 H47,6
Free composizione /composition	L192 P28,7 H64	Fil moduli a dx /rsf units	L90 P48 H29,8
		Fil composizione comò /dresser composition	L180 P48 H89,8







Fil composizione comò / dresser composition L150 P48 H75,4
Fil moduli a dx / rsf units L60 P48 H118,2



Aren letto /bed..... **L186 P213 H106**

Fil comodino /night stand **L60 P48 H29,8**

Fil composizione comò /dresser composition **L135 P48 H75,4**

FIL
/
AREN
volumi
vestiti
con
tonalità
naturali

Bold shapes dressed in natural shades
Volúmenes vestidos de tonos naturales
Volumés revêtus avec des tonalités naturelle
Bezüge in natürlichen Tönen
Объемы, облаченные в натуральные краски





Milano letto /bed L184 P234,8 H94,3
Fil moduli a sx /lsf units L60 P48 H36,9
Fil moduli a dx /rsf units L60 P48 H29,8

FIL
/
MILANO
eleganza
sarto
riale

Tailored elegance
Elegancia artesanal
Élégance de couturier
Elegante Schneiderkunst
Элегантность мастерского
исполнения





Fil composizione comò /dresser composition **L150 P48 H45,6**
Fil composizione scrittoio /desk composition **L228 P59,9 H78,5**



SUITE
SYSTEM
/FIL
testiera
e parete
attrezzata

Accessorised headboard and wall

Cabecera y pared equipadas

Tête de lit et paroi équipée

Kopfteil und Wandverkleidung

Головная спинка и
 оборудованная стенка



Suite system letto /bed	L405 P208,9 H93,2
Fil moduli a sx /lsf units.....	L60 P48 H37,6
Fil moduli a dx /rsf units.....	L100 P48 H37,6
Denny pouf /pouf	L55 P55 H42

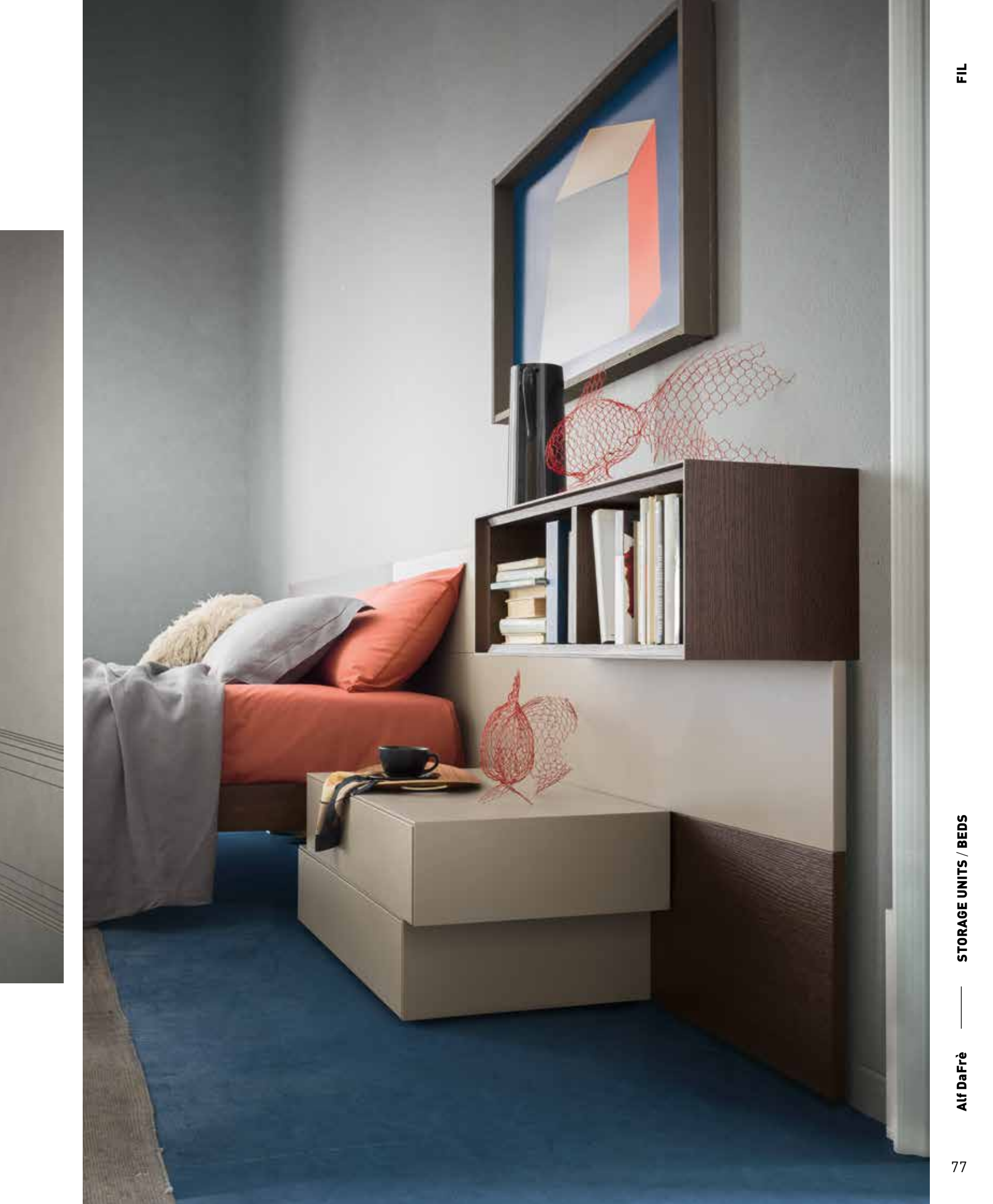

FIL
CALIFORNIA
letto e
contenitori
in un
gioco
di volumi
sospesi
ed a terra

Bed and storage, playing with suspended and floor-standing units

Cama y contenedores en un juego de volúmenes suspendidos y a suelo

Lit et modules dans un jeu de volumes suspendus et au sol

Bett und Anbauelemente: Mehr Rhythmus im Schlafbereich

Кровать и контейнеры в игре подвесных и напольных объемов







California letto /bed	L177 P230 H85,5
Fil moduli a sx /lsf units	L120 P48 H35,6
Fil moduli a dx /rsf units	L135 P48 H37,6
Fil composizione comò con specchiera /dresser composition with mirror.....	L180 P48 H207,6
Fil composizione comò senza specchiera /dresser composition without mirror.....	L180 P48 H75,4

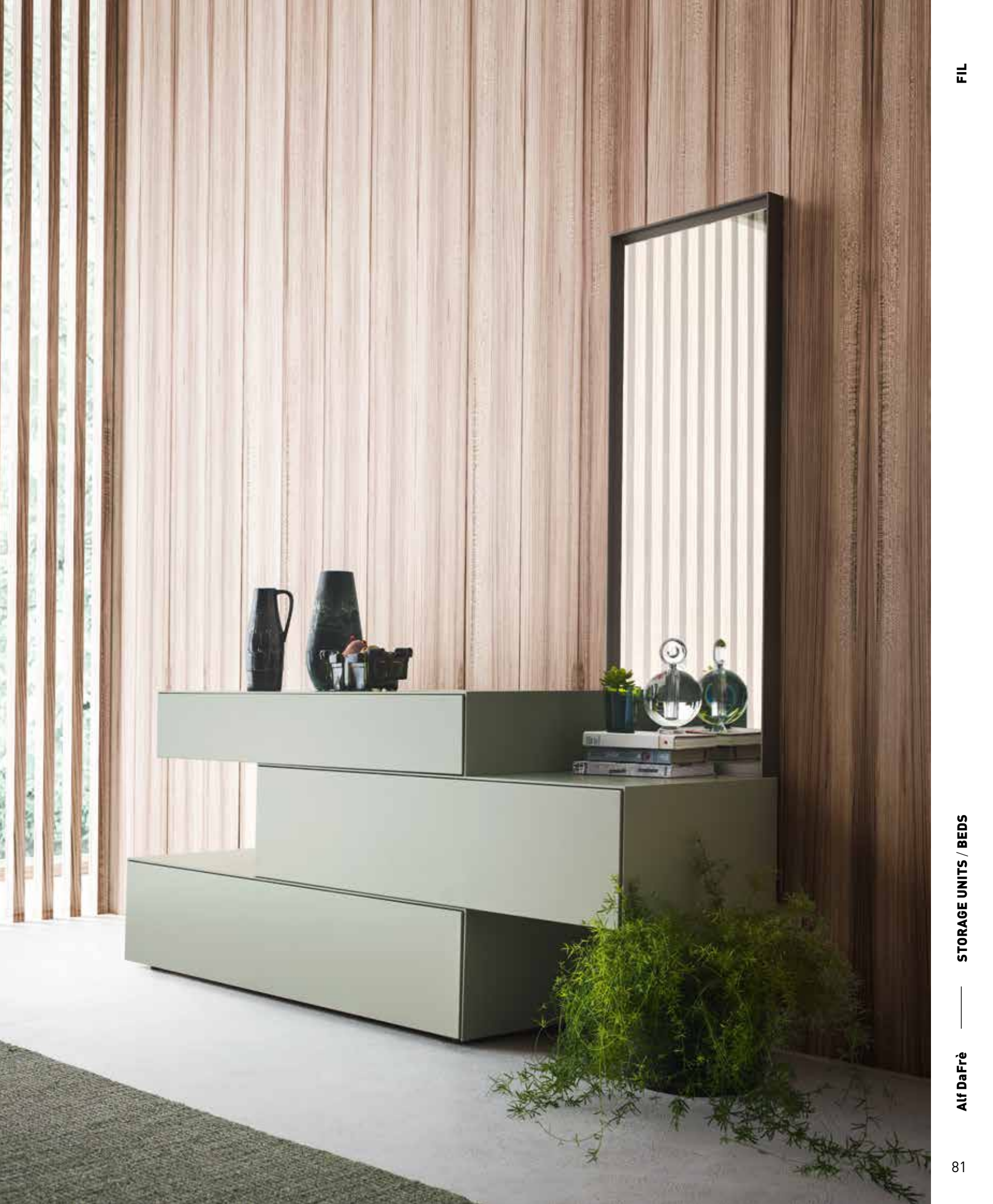



FIL
/
DORIAN
il calore
naturale
del
legno



The natural warmth of wood
La calidez natural de la
madera
La chaleur naturelle du bois
Die natürliche Wärme von
Holz
Естественное тепло дерева

FIL



STORAGE UNITS / BEDS

Alf DaFrè



Dorian letto /bed.....	L180 P219,2 H94
Fil moduli a sx /lsf units	L60 P48 H29,8
Fil moduli a dx /rsf units	L110 P48 H47,6
Fil composizione comò /dresser composition	L210 P48 H45,6
Fil specchiera /mirror.....	L120 P5 H45



FIL
FRANCIS
dinamiche
composizioni
nella zona
notte

Dynamic compositions for
your bedroom

Composiciones dinámicas en
el dormitorio

Compositions dynamiques
dans la zone nuit

Dynamische
Einrichtungskombinationen
im Schlafbereich

Динамичные композиции
в спальне





Francis letto /bed	L190 P219 H115
Fil moduli a sx /lsf units	L60 P48 H17,8
Fil moduli a dx /rsf units	L150 P48 H53,4

Fil

design R.D.A.

Si distingue per la linea filante e minimale. Fil è un gruppo letto componibile con una vasta modularità. Può avere due versioni di piedi o essere appeso a parete, creando ampie possibilità compositive. Si caratterizza inoltre per la scelta nell'apertura tra la piccola maniglia in metallo in posizione asimmetrica o il push-pull.

This piece is characterised by its sleek, minimalist lines. Fil is a modular bed unit which can be used in a wide array of compositions. There are two floor-standing options and it can be wall mounted. There are also two ways to open the units, either using the small, asymmetric metal handle or the push-pull mechanism.

Fil es un conjunto de dormitorio, componible y de gran modularidad, que se distingue por sus líneas fluidas y minimalistas. Está disponible con dos versiones de pata y puede montarse suspendido de la pared, ofreciendo amplias posibilidades de composición. También se caracteriza por sus opciones de apertura: un pequeño tirador de metal en posición asimétrica o push-pull.

Il se distingue pour sa ligne filante et minimale. Fil est un groupe lit pouvant être composé avec une vaste modularité. Il peut avoir deux versions de pieds ou être suspendu au mur, en créant d'amples possibilités de composition. Il se caractérise par ailleurs pour le choix de l'ouverture entre la petite poignée en métal en position asymétrique ou le push-pull.

Fil ist eine kombinierbarer Bettgruppe mit einer schlan- ken und minimalistischen Linie, die dank ihrer Modula- rität vielseitig kombinierbar ist. Bei den Füßen stehen zwei Versionen zur Verfö- gung. Die Elemente können jedoch auch an der Wand montiert werden, sodass zahlreiche Kombinations- möglichkeiten entstehen. Außerdem haben Sie zum Öffnen die Wahl zwischen einem kleinen Metallgriff in asymmetrischer Position oder einer Push-Pull-Öff- nung.

Отличаясь обтекаемыми и минималистскими формами, Fil представляет собой сборный спальный блок с высокой модульностью. Он может иметь два варианта ножек либо быть прикрепленным к стене, создавая широкие композиционные возможности. Характеризуется также двумя вариантами открытия на выбор: с помощью небольшой металлической ручки в асимметричном положении, либо системы открытия «push-pull».

Fil con piedini

Fil with feet / Fil con patas / Fil avec pieds / Fil mit Füßen / Fil с ножками

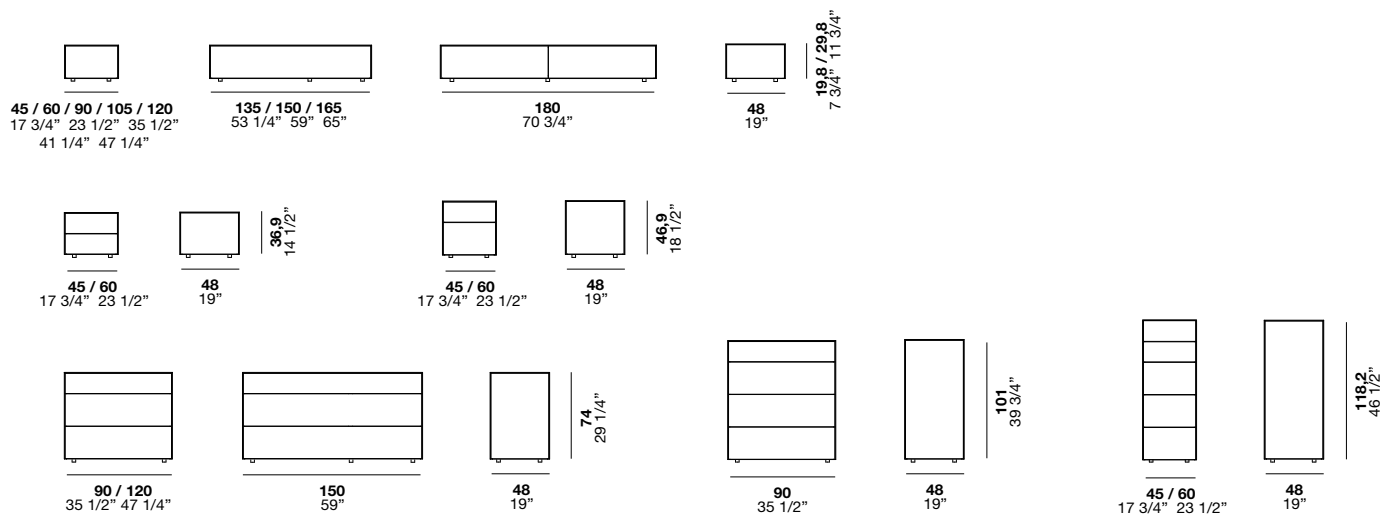

Deposito del modello multiplo del 13/01/2017 al numero 003622075

Fil con piedini in metallo

Fil with metal feet / Fil con patas de metal / Fil avec pieds en métal / Fil mit Füßen aus Metall / Fil с металлическими ножками

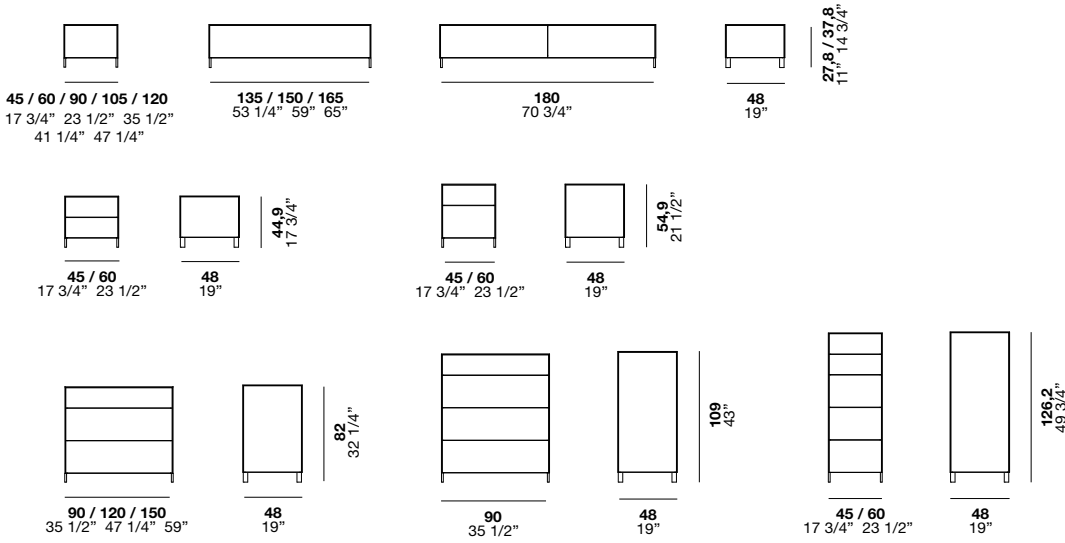

Moduli a giorno

Open units / Módulos abiertos / Modules ouverts / Offene Module / Открытые модули

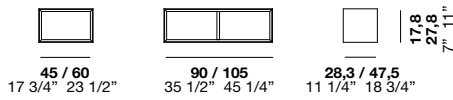

Moduli a giorno a sbalzo

Open units with overhang detailing / Módulos abiertos en voladizo / Modules ouverts avec saillie / Offene Module mit unterschiedlichen Tiefen / Открытые модули со смещением

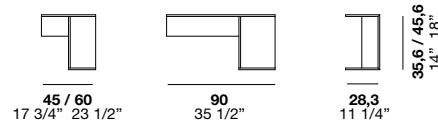



Hobby

HOBBY

.....
gruppo notte / storage units



HOBBY
SKIP
composizione
di linee
orizzontali

Horizontal compositions

Composición de líneas horizontales

Composition de lignes horizontales

Bewegung durch horizontale Linien

Композиция горизонтальных линий









Skip letto /bedL198 P214 H98,2
Hit tavolino /occasional table L38 P38,6 H50

Hobby comodino /night stand L55,7 P44 H42
Hobby comò /dresserL134,2 P52,7 H75,4





Teo letto /bed	L177 P217 H92
Hobby comodino /night stand	L41,7 P44 H42
Hobby comò /dresser composition	L159,6 P52,7 H99,8



Suite system letto /bed	L360 P210 H113,2	Hobby comodino /night stand	L55,7 P44 H42
		Hobby settimanale /4 drw chest	L79,8 P52,7 H99,8



HOBBY / ALLEN il fascino sottile del tessuto e del legno

The subtle charm of fabric
and wood

El sutil encanto del tejido y la
madera

Le charme subtil du tissu et
du bois

Stoff und Holz: faszinierend
und zart

Тонкое очарование ткани и
дерева

Allen letto /bed	L186 P215 H129
Hobby comodino /night stand	L55,7 P44 H42
Hobby comò /dresser	L134,2 P52,7 H75,4
Free* modulo /module.....	L134,2 P52,7 H75,4

*Per questo articolo vedi "Complementi" - Il senso dei dettagli
*For this article see "Complements" - A sense of detail

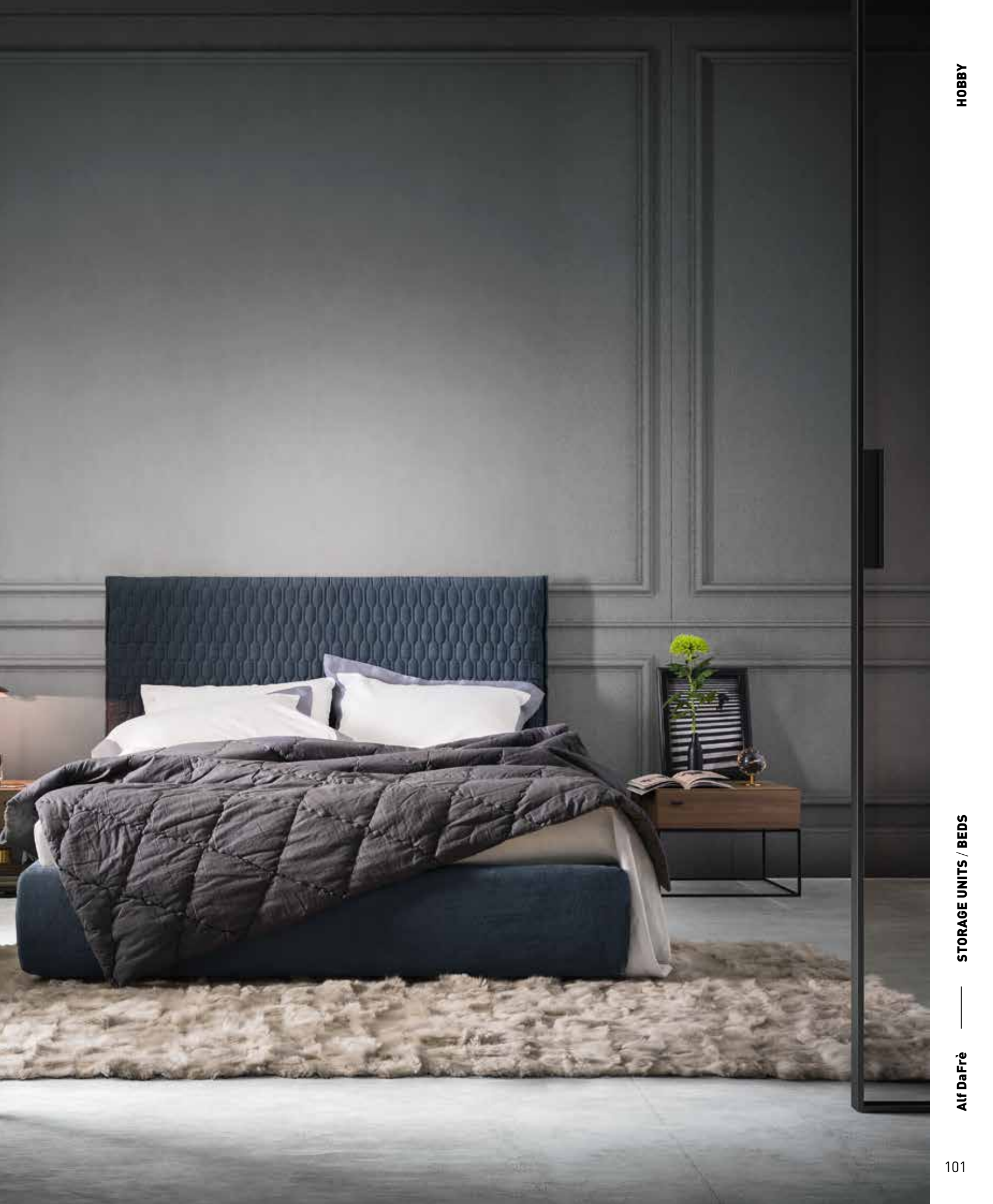



Un gruppo che unisce un design minimale e un' eleganza rigorosa, caratterizzato da elementi ricercati, come il basamento in metallo e le originali manigliette.

This storage unit that combines minimalist design with pure elegance, distinguished by sophisticated details such as the metal base and original small handles.

Un conjunto que une un diseño minimalista y una rigurosa elegancia y que se caracteriza por elementos sofisticados, como la base de metal y los originales tiradores.

Un groupe qui unit un design minimal et une élégance rigoureuse, caractérisé par des éléments recherchés, comme le piètement en métal et les originales petites poignées.

Eine Bettgruppe, die minimales Design und strenge Eleganz kombiniert. Die Gruppe zeichnet sich durch raffinierte Elemente wie das Untergestell aus Metall und den originellen Griff aus.

Группа, в которой объединяется минималистский дизайн и строгая элегантность, характеризуется изысканными элементами, как, например, металлическое основание и оригинальные ручки.

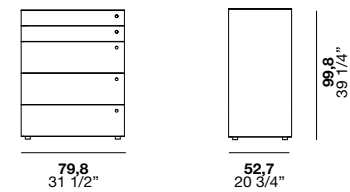
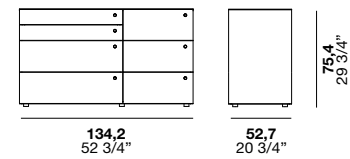

Con basamento

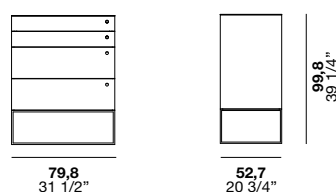
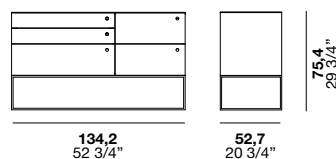
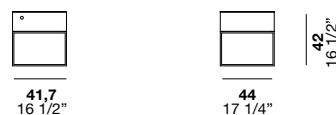

Abbinabile a libreria Up /matching with Up bookcase

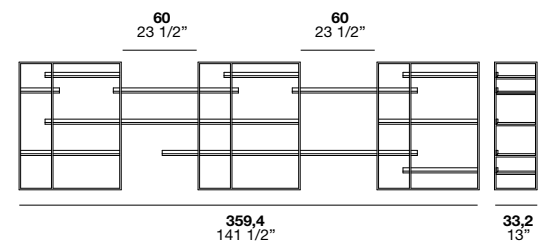
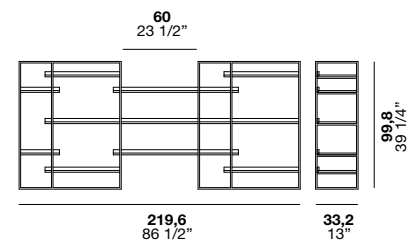
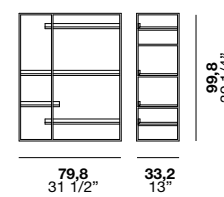



Linea

LINEA

.....
gruppo notte / storage units





LINEA
/
SKIP
un angolo
di relax
e funzio
nalità

A practical corner to relax in

Un rincón de relax y
funcionalidad

Un coin de détente et
fonctionnalité

Entspannung und
Funktionalität treffen
aufeinander

Уголок расслабления и
функциональности







.....	
Skip letto /bed	L352,2 P292,2 H98,2
Linea composizione scrittoio/desk composition	L276 P53 H77,5
Vicky 3* sedia /chair.....	L59 P52 H76,5
Versus* modulo /module.....	L160 P28,3 H24,3

*Per questo articolo vedi "Complementi" - Il senso dei dettagli
 *For this article see "Complements" - A sense of detail



Skip letto /bed	L352,2 P292,2 H98,2
Linea composizione scrittoio/desk composition	L276 P53 H77,5
Vicky 3* sedia /chair.....	L59 P52 H76,5
Versus* modulo /module.....	L160 P28,3 H24,3

*Per questo articolo vedi "Complementi" - Il senso dei dettagli
 *For this article see "Complements" - A sense of detail







Francis letto /bed	L190 P220 H112
Linea comodino /night stand	L64 P53 H27
Domino* modulo /module.....	L48 P28,3 H48
Linea comò /dresser.....	L128 P53 H73

*Per questo articolo vedi "Complementi" - Il senso dei dettagli
 *For this article see "Complements" - A sense of detail

Linea

design R.D.A.

Programma di contenitori che posizionati a terra, appesi o sovrapposti creano soluzioni piacevoli e contenitive. Abbinabile a piccole librerie che arricchiscono il programma dando sfogo a svariate interpretazioni.

This collection of storage units creates pleasant floor-standing, suspended or stacked storage solutions. They can also be teamed with small bookcases to enrich the collection and give free rein to a multitude of interpretations.

Programa de contenedores que, colocados a suelo, suspendidos o superpuestos, crean composiciones agradables y de gran capacidad. Puede combinarse con pequeñas librerías, que completan el programa haciendo posibles diversas interpretaciones.

Programme de modules qui, positionnés au sol, suspendus ou superposés, créent d'agréables solutions de rangement. Associable à de petites bibliothèques qui enrichissent le programme en laissant libre cours aux différentes interprétations.

Ein Programm bestehend aus Stand-, Hänge- oder Aufsatzelementen, mit denen schöne und geräumige Stauraumlösungen geschaffen werden können, die gut zu den kleinen Bücherregalen des Programms passen. Lassen Sie Ihrer Fantasie freien Lauf.

Программа использования контейнеров, которые, будучи расположенными на полу, прикрепленными к стене или установленными один на другой, предлагают приятные с эстетической точки зрения и вместительные решения. Небольшие книжные шкафы расширяют рамки программы, предоставляя возможность для реализации самых различных интерпретаций.

Contenitori con zoccolo

Storage unit with plinth / Contenedores con zócalo / Modules avec socle / Anbauelemente mit Sockel / Контейнеры с цоколем

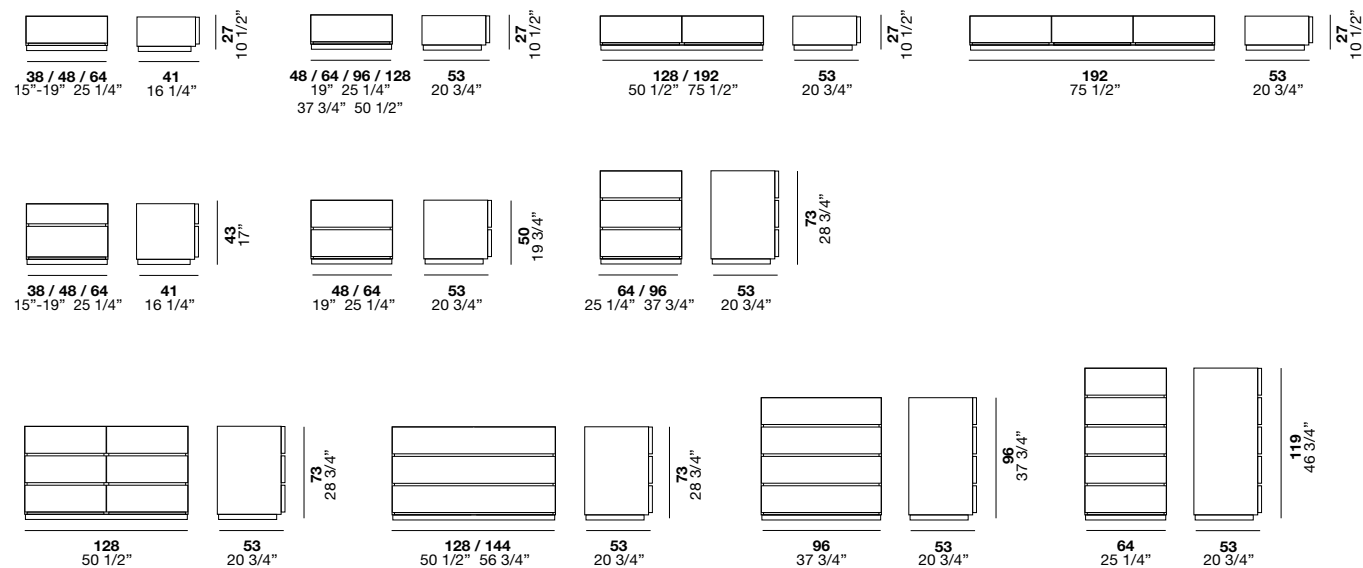

Angolo cieco

Solid corner / Rincón ciego / Angle mort / Festes Eckteil / Глухой угловой модуль

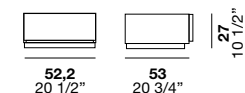

Angolo

Corner / Rincón / Angle / Eckteil / Угловой модуль



Contenitori senza zoccolo

Storage unit without plinth / Contenedores sin zócalo / Modules sans socle / Anbauelemente ohne Sockel / Контейнеры без цоколя

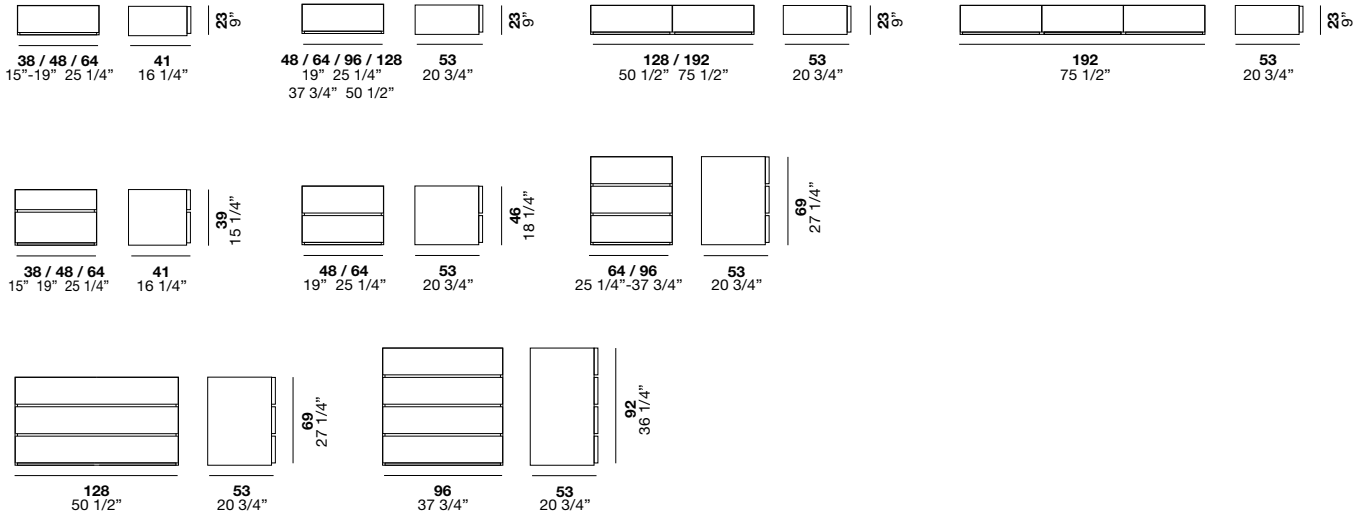

Elementi a giorno

Open units / Elementos abiertos / Éléments ouverts / Offene Elemente / Открытые элементы

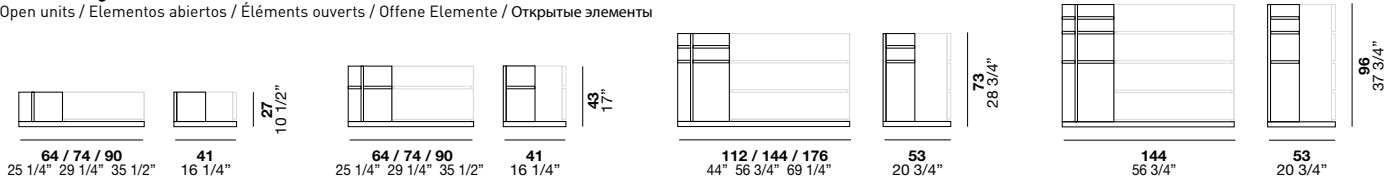

Scrivtoi

Desks / Escritorios / Bureaux / Schreibtische / Письменные столы

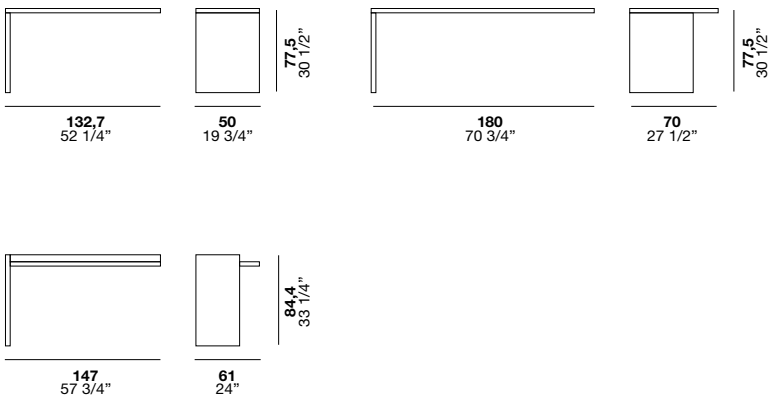



Rim

RIM

.....
gruppo notte / storage units







.....
Jetty letto /bed L174 P212,2 H94,5
Rim comodino /night stand L40 P40 H52
.....



Clipper letto /bedL181,5 P211 H96,3
Rim comodino /night stand.....L40 P40 H52

Wok tavolino /occasional table L27,5 P27,5 H50
Wok box tavolino /occasional table L35 P35 H43





Rim

design **Enrico Cesana**

Rim è un comodino con anta o vano a giorno, si differenzia per la linea curva e le dimensioni compatte. La possibilità del bicolore ne esalta le linee e ne amplia la versatilità.

Rim is a bedside table either with a door or open compartment. It stands out for its curved lines and compact size. The two-tone option brings out its shape and makes it a truly versatile piece.

Rim es una mesita de noche con puerta o compartimento abierto que se caracteriza por sus formas curvas y dimensiones compactas. La variante bicolor disponible acentúa sus perfiles y la hace aún más versátil.

Rim est un chevet avec porte ou niche ouverte, il se différencie par sa ligne arrondie et ses dimensions compactes. La possibilité du bicolore en exalte les lignes et en augmente la versatilité.

Rim ist ein Nachttisch mit auffallenden Rundungen und kompakten Formen, die Türen in zweifarbiger Ausführung unterstreichen seine linearen Formen und sorgt für mehr Kombinationsmöglichkeiten.

Rim - тумбочка с дверцей или открытой полкой, отличается изогнутыми линиями и компактными размерами. Возможность двухцветного исполнения подчеркивает ее форму и расширяет ее универсальность.



40
15 3/4"



40
15 3/4"

52
20 1/2"



40
15 3/4"



40
15 3/4"

52
20 1/2"



Segno

SEGNO

gruppo notte / storage units



SEGNO
/
MORRISON
geometria
grafica
tra
gola
e top

Schematic shapes between
the groove and the top

Geometría gráfica entre
ranura y encimera

Géométrie graphique entre
gorge et dessus

Geometrische Muster
zwischen Leiste und Platte

Графическая геометрия
между пазом и столешницей



Morrison letto /bed	L197 P230 H92
Segno comodino /night stand	L58,4 P45 H38,7
Segno settimanale /5 drw chest	L58,4 P48 H131,7



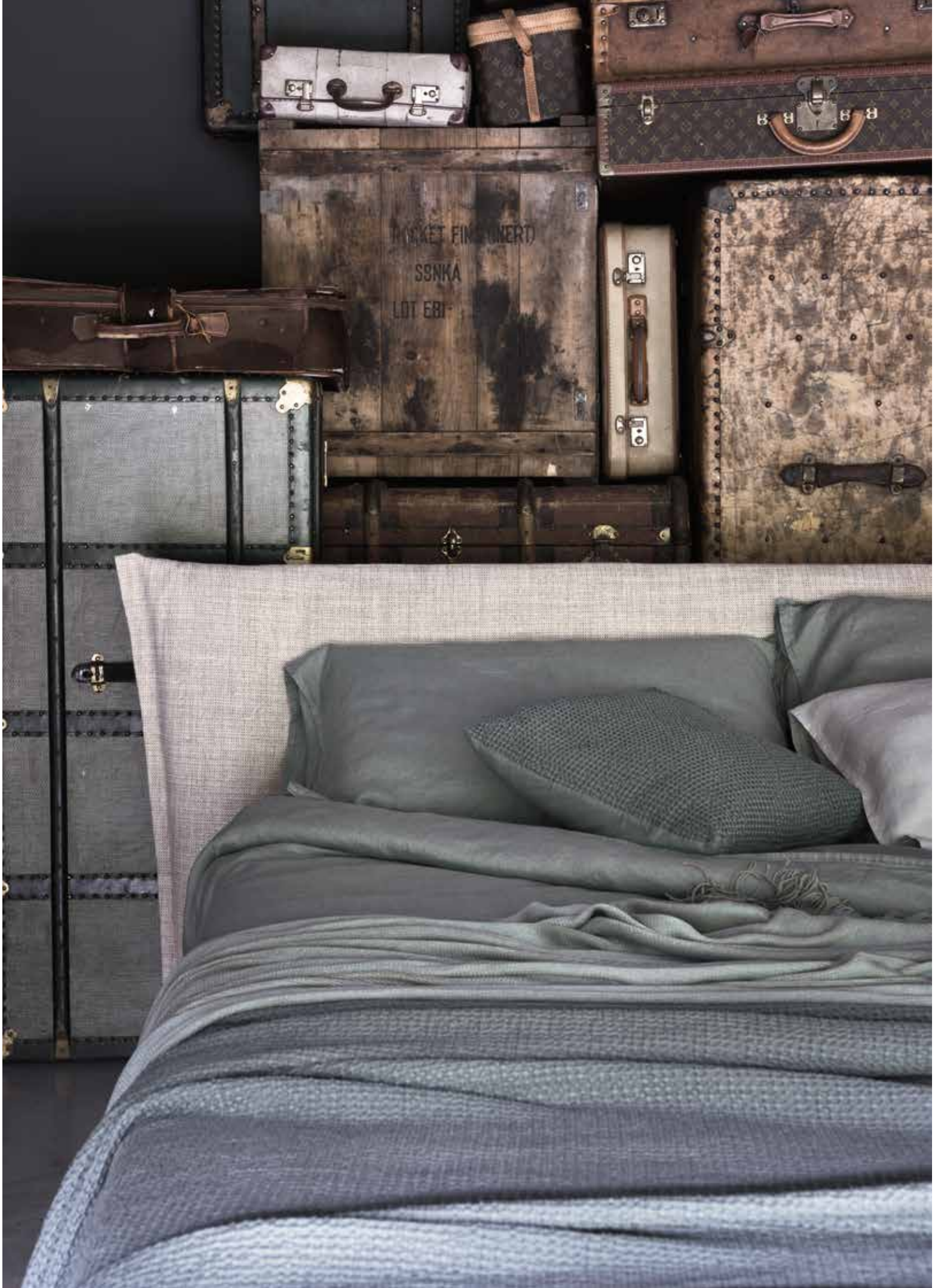









Francis letto /bed	L190 P219 H115
Segno comodino /lsf units	L58,4 P45 H38,7
Segno comò /dresser	L143,9 P48 H70,1



Da-Do letto /bed	L173 P214,7 H93,7
Segno comodino /night stand	L58,4 P45 H38,7
SEgno comò /dresser	L143,9 P48 H40,1





Segno

design **Bruna Vaccher**

Un top in forte spessore alternato ad un sistema di gole sottili crea un grafismo che permette anche un gioco di colori.

The thick-top and thin-grooves combination creates a visual effect that also plays with colour.

Una encimera de gran espesor alternada con un sistema de finas ranuras crea un patrón que permite también un juego de colores.

Un dessus très épais alterné à un système de gorges fines crée un graphisme qui permet également un jeu de couleurs.

Die dicke Platte schafft abwechselnd mit den schmalen Kehlen leisten ein geometrisches Muster mit einem schönen Farbenspiel.

Столешница значительной толщины в сочетании с системой тонких пазов создает графику с характерной игрой цветов.

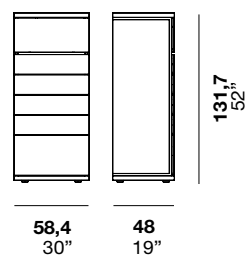
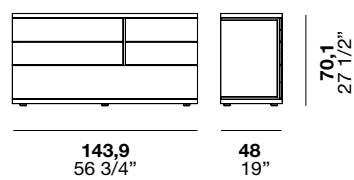
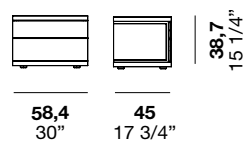



Carta
canta
villan
dorme.

*Seren di notte
non val tre
pere cotte.*

CHI CERCA
TROVA
E CHI DORME
SOGNA

Timeless

TIMLESS

gruppo notte / storage units

La notte
porta
il consiglio

Non
svegliare
il cane
che
dorme.

Chi dorme
non piglia
pesci.







Jordy letto /bed.....	L165,5 P216,4 H101,8
Timeless comodino /night stand	L60 P45 H30,9
Timeless settimanale /5 drw.ches.....	L60 P45 H110,6



TIMELESS
XILO
il legno è
protagonista
assoluto

Wood takes centre stage
La maderà como
protagonista absoluta
Le bois est le protagoniste
absolu
Holz spielt die Hauptrolle
Дерево - неоспоримое
главное действующее лицо







Xilo letto /bed	L174,5 P216 H95,2
Timeless comodino /night stand	L75 P45 H30,9
Shindo* poltroncina /armchair.....	L75 P80 H72
Timeless comò /dresser	L145 P55 H70

*Per questo articolo vedi "Complementi" - Il senso dei dettagli
 *For this article see "Complements" - A sense of detail

TIMELESS
CLOUD
/
legno,
acciaio e
tessuto
in
armonia



Wood, steel and fabric in harmony

Madera, acero y tejido en perfecta armonía

Bois, acier et tissu en harmonie

Holz, Stahl und Stoff harmonisch vereint

Дерево, сталь и ткань в полной гармонии



TIMELESS

STORAGE UNITS / BEDS

Alf DaFrè





Cloud letto/bed L170 P225,5 H93
Timeless comodino /night stand L60 P45 H36
Timeless settimanale /5 drw chest L60 P45 H110





Aston letto /bed	L180 P215 H128
Timeless comodino /night stand	L60 P45 H36
Timeless comodino /night stand	L45 P45 H43,7
Timeless comò /dresser	L145 P55 H70



Timeless

design **Enrico Cesana**

Timeless è un gruppo letto dal disegno sempre attuale con stondatura e sagomatura dei fianchi e maniglia in metallo. Disponibile in variante comodino comò e settimanale in diverse misure.

Timeless is an on-trend bedroom suite with shaped and rounded sides and a metal handle. Available as a bedside table, dresser and chest of drawers in various sizes.

Timeless es un conjunto de dormitorio de diseño intemporal con costados redondeados y perfilados y tirador de metal. Disponible en variante mesita de noche, cómoda y semanario en diversas medidas.

Timeless est un groupe lit au dessin toujours actuel avec arrondissement et façonnage des côtés et poignée en métal. Disponible dans la variante chevet, commode et semainier en différentes dimensions.

Timeless ist eine Bettgruppe mit einem zeitlosen Design, das sich durch abgerundete und geformte Seiten und Metallgriffe auszeichnet. Erhältlich in unterschiedlichen Größen in der Variante Nachttisch, Kommode und Hochkommode.

Timeless - это спальный блок с не теряющим своей актуальности дизайном, отличающимся закруглениями и фигурной обработкой боковин и металлических ручек. Предлагается в комплекте с тумбочкой, комодом и высоким комодом различных размеров.

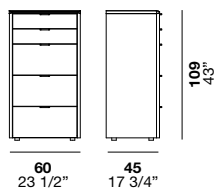
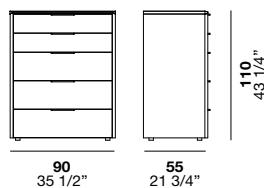
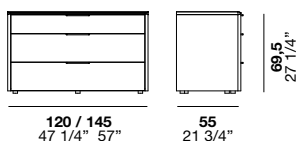
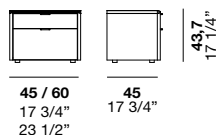
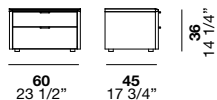
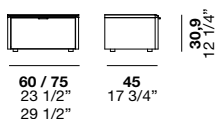



Twice

TWICE

.....
gruppo notte / storage units





TWICE

/

OREGON

**una
sensazione
avvolgente**



An enveloping embrace
Una sensación acogedora
Une sensation enveloppante
Gemütlich umhüllt schlafen
Обволакивающее ощущение



Oregon letto /bed	L187 P225 H102
Twice comodino /night stand	L64 P47,4 H44,4
Twice settimanale /5 drw chest	L64 P47,4 H123,8





.....
Xilo letto /bedL174,5 P216 H95,2
Twice comò /dresserL120,3 P54 H74,2
.....

TWICE
XILO
/
essen
zialità
quasi
assoluta

Absolute simplicity
Sencillez casi absoluta
Essentiel presque absolu
Aufs Wesentliche reduziert
Почти абсолютная
строгость стиля





Comodini, comò e settimanale lineari e ben proporzionati sfruttano una "catena" come presa per una agevole apertura. Tale rientranza caratterizza ulteriormente il mobile nella versione con finitura in contrasto.

These bedside tables, dressers and chests of drawers with well-proportioned, linear lines feature a "chain" groove that provides for easy opening. This recess is particularly characteristic in the models featuring a contrasting colour.

Mesitas de noche, cómoda y semanario lineales y bien proporcionados que aprovechan un "tirante" como asidero para una fácil apertura. Este entrante caracteriza aún más el mueble en la versión con acabado en contraste.

Chevets, commode et semainier linéaires et bien proportionnés exploitent une "chaîne" comme prise pour une ouverture facile. Cette recoupe caractérise ultérieurement le meuble dans la version avec finition en contraste.

Geradlinige Nachttische, Kommoden und Hochkommoden mit schönen Proportionen mit pfiffiger Öffnung: Ein „Band“ sorgt für ein bequemes Öffnen. In der Version mit kontrastierenden Ausführungen verleiht dieser Aussparung dem Möbelstück einen besonderen Charakter.

Тумбочки, комод и высокий комод и прямолинейных и пропорциональных форм используют "цепь" в качестве захвата для удобного открытия. Такое углубление является еще одним характерным элементом мебели в версии с контрастной отделкой.

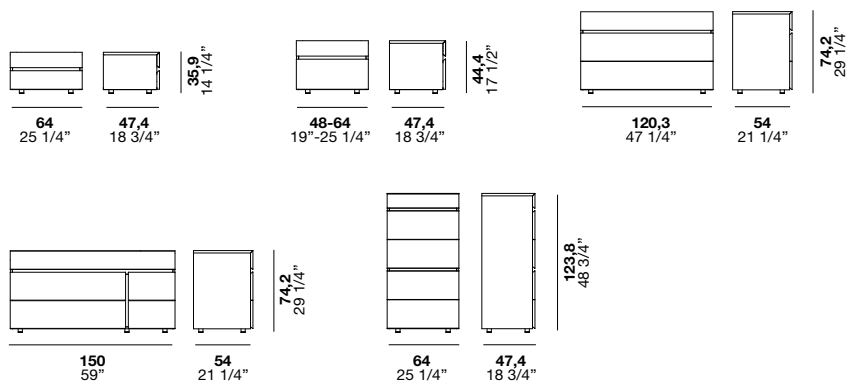



IS NOT ART



Tavolini California

TAVOLINI CALIFORNIA

.....
tavolini / occasional tables





California tavolino

design R.D.A.

California è un tavolino con struttura legno disponibile in due larghezze.

Il divisorio verticale in metallo è elemento caratterizzante e funzionale.

California is an occasional table with a wooden structure available in two width measurements.

The central focus is a practical, vertical metal partition.

California es una mesita con estructura de madera disponible en dos anchos.

El divisor vertical de metal es un elemento caracterizador y funcional.

California est une table basse avec structure en bois disponible en deux largeurs.

La séparation verticale en métal est un élément caractérisant et fonctionnel.

California ist ein Beistelltisch mit einem Korpus aus Holz und ist in zwei Breiten erhältlich.

Die vertikale Mittelseite aus Metall ist funktional und verleiht diesem Tisch seinen besonderen Charakter.

California - столик с деревянным каркасом, предусмотрен в двух вариантах ширины. Вертикальная металлическая перегородка представляет собой характерный и функциональный элемент.

Materiali e finiture

Struttura:

Rovere termocotto / Fashion wood / Rovere colori opachi / Colori opachi / Colori lucidi

Divisorio:

Verniciato Bianco / Verniciato Ghisa / Colori opachi

Materials and finishes

Structure:

Baked oak / Fashion wood / Matt coloured oak / Matt colours / High-gloss colours

Partition:

Bianco painted / Ghisa painted / Matt colours

Materiales y acabados

Materiales y acabados

Estructura:

Roble termotratado / Fashion wood / Roble teñido colores mate / Colores mate / Colores brillantes

Divisor:

Barnizado Bianco / Barnizado Ghisa / Colores mate

Matériaux et finitions

Matériaux et finitions

Structure :

Chêne thermo-traité / Fashion wood / Chêne laqué mat / Laqués mats / Laqués brillants

Séparation :

Verni Bianco / Verni Ghisa / Laqués mats

Materialien und Ausführungen

Korpus:

Thermo-Eiche/ Fashion Wood / Eiche in matten Farben / Matte Farben / Glänzende Farben

Mittelseite:

Lackiert Bianco / Gusseisen lackiert/ Matte Farben

Материалы и варианты отделки

Каркас:

Дуб термокотто / Fashion wood / Дуб матовых цветов / Матовые цвета / Глянцевые цвета

Перегородка:

Крашенный Bianco / Крашенный Ghisa / Матовые цвета

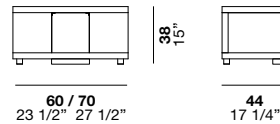



Ceppo

design R.D.A.

Ceppo è un tavolino ricavato da un unico pezzo di tronco di rovere cresciuto sulle rive dei fiumi. Segato, scortecciato e levigato è distinto da un caldo colore naturale e fini spaccature.

The Ceppo occasional table is built using a single piece of oak trunk grown on riverbanks. Sawn, debarked and smoothed, it stands out for its warm natural colour and fine cracks.

Ceppo es una mesita elaborada a partir de una única pieza de tronco de roble procedente de orillas fluviales. La madera aserrada, descortezada y lijada se distingue por un cálido tono natural y leves fisuras.

Ceppo est une table basse obtenue à partir d'un seul tronc de chêne grandi sur les rives des fleuves. Scié, écorcé et poli, il se distingue pour son coloris naturel et chaud et pour ses fines fissures.

Ceppo ist ein Beistelltisch aus einem Stück Eichenholz eines Baums, der von einem Flussufer stammt. Nach dem Sägen und Entrinden wurde das Holz geschliffen, sodass die Wärme seiner natürlichen Farbe und die feinen Risse im Material zur Geltung kommen.

Серро - столик, изготовленный из единого элемента дуба речных побережий. Срубленный, очищенный от коры и отполированный, характеризуется теплым натуральным цветом и тонкими прорезями.

Materiali e finiture

Struttura:
Rovere

-

Materials and finishes

Structure:
Oak

-

Materiales y acabados

Estructura:
Roble

-

Matériaux et finitions

Structure :
Chêne

-

Materialien und Ausführungen

Korpus:
Eiche

-

Материалы и варианты отделки

Каркас:
Дуб

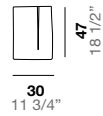
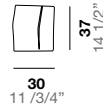

Denny

design R.D.A.





Denny

DENNY

.....
pouf





Denny è un pouf imbottito e sfoderabile (nelle versioni tessuto ed ecopelle) disponibile in tre misure. Caratterizzato da forme tondeggianti e rastremate funge da seduta o pratico appoggio.

Denny is a padded footstool with a removable cover (in the fabric and ecological leather models), which is available in three sizes. It features rounded and tapered shapes, and can be used as either a seat or a practical rest.

Denny es un puff tapizado y desenfundable (en las versiones de tejido y eco-piel) disponible en tres tamaños. Caracterizado por unas formas redondeadas y ahusadas, sirve de asiento o cómodo apoyo.

Denny est un pouf rembourré et déhoussable (dans les versions tissu et éco-cuir) disponible en trois dimensions. Caractérisé par des formes arrondies et affinées il sert d'assise ou de pratique appui.

Denny ist ein Polsterhocker mit abnehmbarem Bezug (in den Versionen mit Stoff- oder Kunstlederbezug) und ist in drei Größen erhältlich. Seine runde und sich nach oben verjüngen Form dient als Sitzfläche oder praktische Ablagefläche.

Denny - мягкий со снимаемой обивкой пуф (в тканевом варианте и из экокожи) предусмотрен в трех размерах. Характеризуется закругленными и суженными формами, предусмотрен в качестве сиденья или практичной опоры.

Materiali e finiture

Rivestimento:

Tessuti / Pelle / Ecopelle

Materials and finishes

Cover:

Fabric / Leather / Ecological leather

Materiales y acabados

Revestimiento:

Tessuti / Piel / Eco-piel

Matériaux et finitions

Revêtement :

Tissus / Cuir / Eco-cuir

Materialien und Ausführungen

Bezug:

Stoff / Leder / Kunstleder

Материалы и варианты отделки

Обивка:

Ткань / Кожа / Экокожа

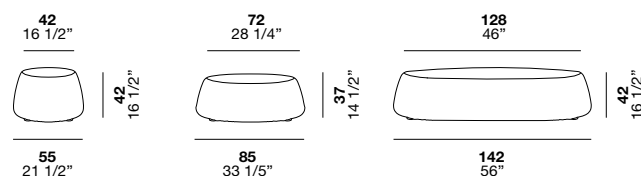



design **Haften Studio**

Hit è un tavolino quadrato con struttura in metallo. Versatile, con un pratico ripiano, si differenzia per la sua "grafica a fori" nel top.

Hit is a square occasional table with a metal structure. It is versatile, thanks to the practical shelf, and it stands out for its slot pattern in the table top.

Hit es una mesita cuadrada con estructura de metal. Resulta versátil, con una cómoda balda, y se diferencia por su "gráfico de orificios" en el sobre.

Hit est une table basse ronde avec structure en métal. Versatile, avec une pratique étagère, elle se différencie pour la "graphique à trous" du dessus.

Hit ist ein quadratischer Beistelltisch mit einem Korpus aus Metall. Vielseitig und mit einem praktischen Fachboden punktet dieser Tisch mit einem Lochmuster in der Tischplatte.

Hit - квадратный столик с металлическим каркасом. Универсальный, с практичной полкой, характеризуется особой "перфорированной графикой" столешницы.

Materiali e finiture

Struttura:

Verniciato bianco / Verniciato nero trasparente lucido / Colori opachi

-

Materials and finishes

Structure:

Bianco painted / High-gloss transparent nero painted / Matt colours

-

Materiales y acabados

Estructura:

Barnizado blanco / Barnizado nero trasparente brillante / Colores mate

-

Matériaux et finitions

Structure :

Verni bianco / Verni nero transparent brillant / Laqués mats

-

Materialien und Ausführungen

Korpus:

Lackiert Bianco / Lackiert Nero transparent glänzend / Matte Farben

-

Материалы и варианты отделки

Каркас:

Крашенный bianco / Крашенный nero прозрачный гляцевый / Матовые цвета

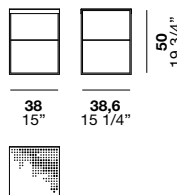



Kobe

design R.D.A.

Kobe è un tavolino quadrato o rettangolare con struttura in metallo verniciato e piano

Estremamente pulito nella linea è disponibile in tre misure.

Kobe is a square or rectangular occasional table with a painted metal structure and a wooden top.

It has an extremely clean-cut design and is available in three sizes.

Kobe es una mesita cuadrada o rectangular con estructura de metal barnizado y sobre de madera. Presenta unas líneas sumamente limpias y está disponible en tres tamaños.

Kobe est une table basse carrée ou rectangulaire avec structure en métal verni et plateau en bois. À la ligne extrêmement nette, elle est disponible en trois dimensions.

Kobe ist ein quadratischer oder rechteckiger Beistelltisch mit einem Korpus aus lackiertem Metall und einer Platte aus Holz. Dieser Tisch mit seinem äußerst geradlinigen Design ist in drei Größen erhältlich.

Kobe - квадратный или прямоугольный столик с металлическим крашеным каркасом и деревянной столешницей. Характеризуется максимально чистыми линиями, предусмотрен в трех размерах.

Materiali e finiture

Piano:

Rovere termocotto / Fashion wood / Rovere colori opachi / Colori opachi / Colori lucidi

Struttura:

Verniciato bianco / Verniciato nero trasparente lucido / Colori opachi

-

Materials and finishes

Top:

Baked Oak / Fashion wood / Matt coloured oak / Matt colours / High-gloss colours

Structure:

Bianco painted / High-gloss transparent nero painted / Matt colours

-

Materiales y acabados

Sobre:

Roble termotratado / Fashion wood / Roble teñido colores mate / Colores mate / Colores brillantes

Estructura:

Barnizado blanco / Barnizado nero transparente brillante / Colores mate

-

Matériaux et finitions

Plateau :

Chêne thermo-traité / Fashion wood / Chêne laqué mat / Laqués mats / Laqués brillants

Structure :

Verni bianco / Verni nero transparent brillant / Laqués mats

-

Materialien und Ausführungen

Platte:

Thermo-Eiche / Fashion Wood / Eiche matte Farben / Matte Farben / Glänzende Farben

Korpus:

Lackiert Bianco / Lackiert Nero transparent glänzend / Matte Farben

-

Материалы и варианты отделки

Столешница:

Дуб термочотто / Fashion wood / Дуб матовых цветов / Матовые цвета / Глянцевые цвета

Каркас:

Крашенный bianco / Крашенный nero прозрачный глянцевый / Матовые цвета

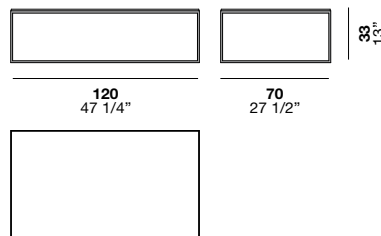
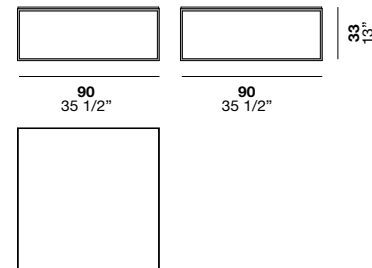
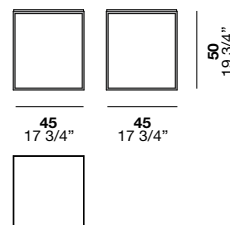



design **Haften Studio**

Life è un tavolino con struttura legno disponibile in tre varianti: rotondo con tre gambe e rettangolare con quattro gambe in due misure.

The Life occasional table has a wooden structure and is available in three versions: round with three legs, or rectangular with four legs, in two different sizes.

Life es una mesita con estructura de madera disponible en tres variantes: redonda con tres patas y rectangular con cuatro patas en dos medidas.

Life est une table basse avec structure en bois disponible en trois variantes : ronde avec trois pieds et rectangulaire avec quatre pieds en deux dimensions.

Life ist ein Beistelltisch mit Korpus aus Holz, der in drei Varianten erhältlich ist: rund mit drei Beinen und rechteckig mit vier Beinen in zwei Höhen.

Life представляет собой столик с деревянным каркасом, предусмотренный в трех вариантах: круглый с тремя ножками и прямоугольный с четырьмя ножками, предусмотрен в двух размерах.

Materiali e finiture

Struttura:

Rovere termocotto / Fashion wood / Rovere colori opachi / Colori opachi

-

Materials and finishes

Structure:

Baked oak / Fashion wood / Matt coloured oak / Matt colours

-

Materiales y acabados

Estructura:

Roble termotratado / Fashion wood / Roble teñido colores mate / Colores mate

-

Matériaux et finitions

Structure :

Chêne thermo-traité / Fashion wood / Chêne laqué mat / Laqués mats

-

Materialien und Ausführungen

Korpus:

Thermo-Eiche / Fashion Wood / Eiche matte Farben / Matte Farben

-

Материалы и варианты отделки

Каркас:

Дуб термочотто / Fashion wood / Дуб матовых цветов / Матовые цвета

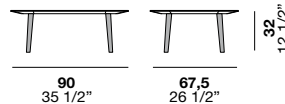
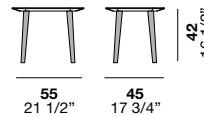
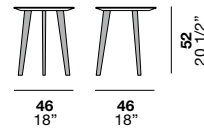



Tuft

design **Enrico Cesana**

Tuft è un tavolino rotondo con struttura in metallo disponibile in 2 misure.

La parte superiore è realizzata come un "vassoio" a cui può essere abbinato un piano in legno.

Tuft is a round occasional table with a metal structure, available in 2 sizes.

The surface is made like a tray, which can be combined with a wooden top.

Tuft es una mesita redonda con estructura de metal, disponible en 2 tamaños.

La parte superior está realizada a modo de "bandeja" a la que se puede unir un sobre de madera.

Tuft est une table basse ronde avec structure en métal disponible en 2 dimensions.

La partie supérieure est réalisée comme un "plateau" auquel peut être associé un plateau en bois.

Tuft ist ein runder Beistelltisch mit einem Korpus aus Metall und ist in zwei Größen erhältlich.

Die Platte ist wie ein Tablett gearbeitet, das mit einer Holzplatte kombiniert werden kann.

Tuft - круглый столик с металлическим каркасом, предусмотрен в 2 размерах. Верхняя часть выполнена в виде "подноса", с которым можно обеспечить сочетание деревянной столешницы.

Materiali e finiture

Struttura:

Verniciato bianco / Verniciato ghisa / Verniciato rame brunito / Colori opachi

Inserto piano:

Rovere termocotto / Fashion wood / Colori opachi

Materials and finishes

Structure:

Bianco painted / Ghisa painted / Rame brunito painted / Matt colours

Top insert:

Baked oak / Fashion wood / Matt colours

Materiales y acabados

Estructura:

Barnizado blanco / Barnizado ghisa / Barnizado rame brunito / Colores mate

Inserto del sobre:

Roble termotratado / Fashion wood / Colores mate

Materialien und Ausführungen

Korpus:

Lackiert Bianco / Lackiertes Gusseisen / Lackiert Kupfer brüniert / Matte Farben

Platteneinsatz:

Thermo-Eiche / Fashion Wood / Matte Farben

Материалы и варианты отделки

Каркас:

Крашенный bianco / Крашенный ghisa / Крашенный rame brunito / Матовые цвета

Вставка столешницы:

Дуб термокотто / Fashion wood / Матовые цвета

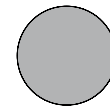
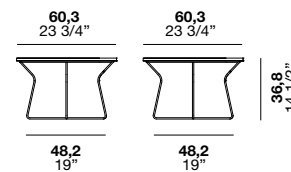
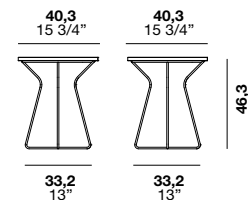
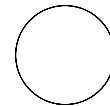
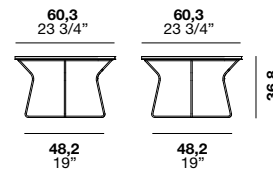
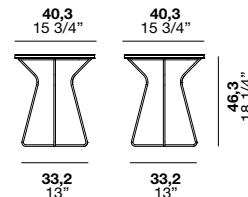

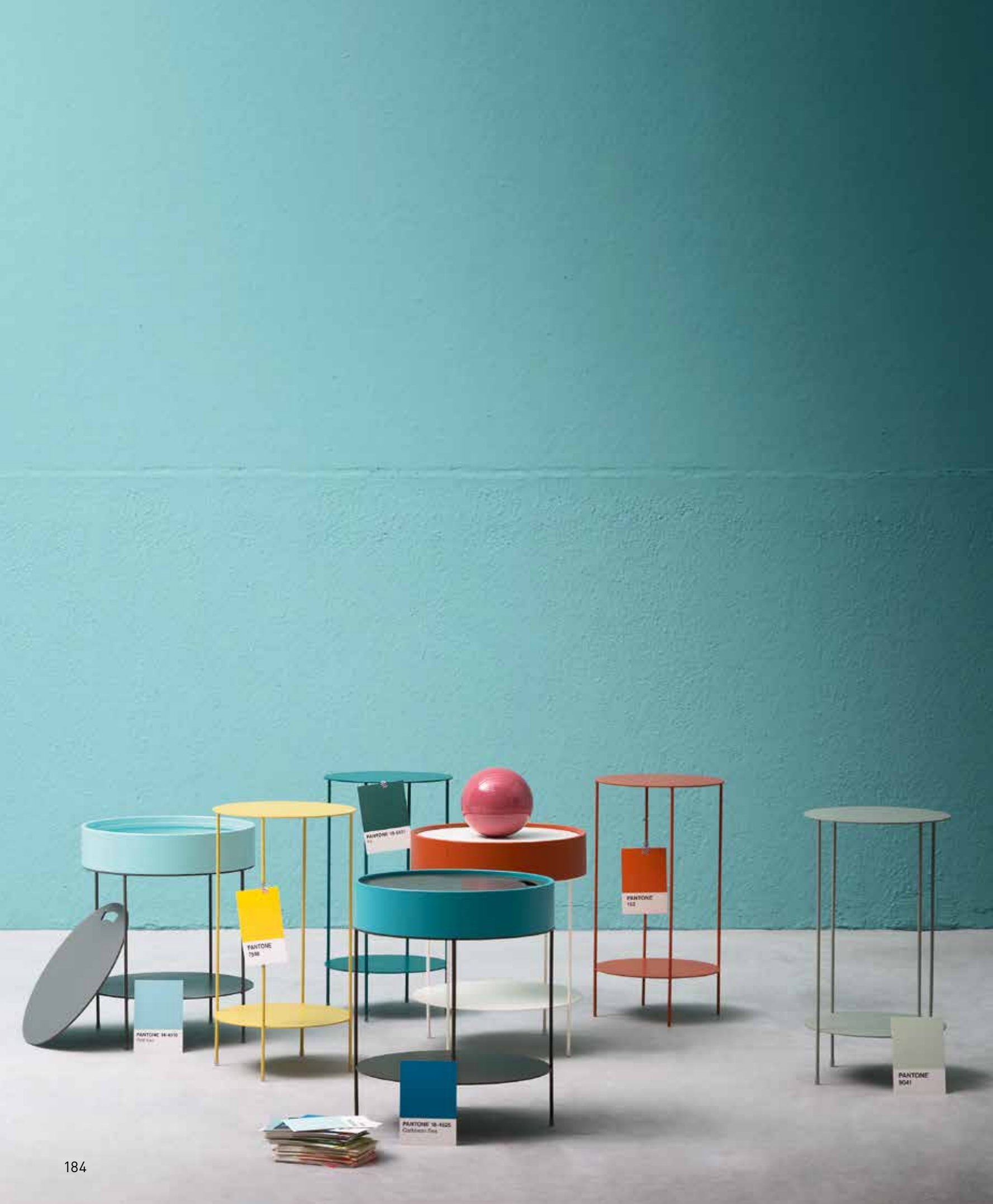

PANTONE 16-4010
Pantone 16-4010

PANTONE 758
Pantone 758

PANTONE 16-6071
Pantone 16-6071

PANTONE 152
Pantone 152

PANTONE 16-4125
Cultures-Sea

PANTONE 9041
Pantone 9041

Wok / Wok Box

design **Enrico Cesana**

Wok è un tavolino rotondo con struttura in metallo.
Wok Box si differenzia per il contenitore legno nella parte superiore chiusa un coperchio che all'occorrenza diventa un pratico vassoio con impugnatura sagomata.

Wok is a round occasional table with a metal structure.
Wok Box differs in that it has a wooden storage unit on the top, which features a cover that can be turned into a practical tray with a shaped handle.

Wok es una mesita redonda con estructura de metal.
Wok Box se diferencia por el contenedor de madera, cerrado por arriba con una tapa que, cuando hace falta, se convierte en una cómoda bandeja con agarre conformado.

Wok est une table basse ronde avec structure en métal.
Wok Box se différencie pour le module en bois sur la partie supérieure fermée avec un couvercle qui à l'occurrence devient un pratique plateau avec poignée galbée.

Wok ist ein runder Beistelltisch mit einem Korpus aus Metall.
Wok Box bietet zudem eine Aufbewahrungsbox im oberen Teil des Tisches, welcher mit einer Platte verschlossen wird, die dank der eingearbeiteten Aussparung zu einem praktischen Tablett wird.

Wok - круглый столик с металлическим каркасом.
Wok Box характеризуется деревянным контейнером в верхней части, закрытым крышкой, который при необходимости становится практичным подносом с профильной ручкой.

Materiali e finiture

Struttura:

Verniciato bianco / Verniciato ghisa / Colori opachi

Contenitore:

Fashion wood / Rovere colori opachi / Colori opachi

Materials and finishes

Structure:

Bianco painted / Ghisa painted / Matt colours

Storage unit:

Fashion wood / Matt coloured oak / Matt colours

Materiales y acabados

Estructura:

Barnizado blanco / Barnizado ghisa / Colores mate

Contenedor:

Fashion wood / Roble teñido colores mate / Colores mate

Matériaux et finitions

Structure :

Verni bianco / Verni ghisa / Laqués mats

Module :

Fashion wood / Chêne laqué mat/ Laqués mats

Materialien und Ausführungen

Korpus:

Lackiert Bianco / lackiert Gusseisen / Matte Farben

Aufbewahrungsbox:

Fashion Wood / Eiche matte Farben / Matte Farben

Материалы и варианты отделки

Каркас:

Крашенный bianco / Крашенный ghisa / Матовые цвета

Контейнер:

Fashion wood / Дуб матовых цветов / Матовые цвета

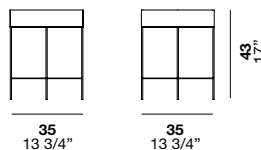
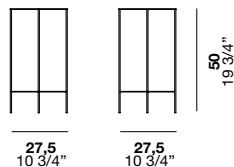



Up

design **Haften Studio**

Up è una libreria con struttura in metallo verniciato e mensole in varie essenze o laccati. Up è disponibile in tre configurazioni.

The Up bookcase has a painted metal structure and shelves which are available in various wood finishes or lacquer colours. Up is available in three configurations.

Up es una librería con estructura de metal barnizado y estantes de diversas maderas o lacados. Up está disponible en tres configuraciones.

Up est une bibliothèque avec structure en métal verni et des étagères en différents bois ou laquées. Up est disponible en trois configurations.

Up ist ein Regal mit einem Korpus aus lackiertem Metall und Borden, die in unterschiedlichen Holzarten oder verschiedenen Lackierungen erhältlich sind. Up ist in drei Varianten erhältlich.

Up - книжный шкаф с каркасом из крашеного металла и полками из различного дерева или в крашеной отделке. Up предусмотрен в трех конфигурациях.

Materiali e finiture

Struttura:

Verniciato bianco / Verniciato Titanio / Verniciato nero trasparente lucido / Colori opachi

Mensole:

Rovere termocotto / Fashion wood / Rovere colori opachi / Colori opachi / Nobilitato

-

Materials and finishes

Structure:

Bianco painted / Titanio painted / High gloss transparent nero painted / Matt colours

Shelves:

Baked oak / Fashion wood / Oak matt colours / Matt colours / Surfaced

-

Materiales y acabados

Estructura:

Barnizado blanco / Barnizado Titanio / Barnizado nero transparente brillante / Colores mate

Estantes:

Roble termotratado / Fashion wood / Roble teñido colores mate / Colores mate / Ennoblecido

-

Matériaux et finitions

Structure :

Verni bianco / Verni Titanio / Verni nero trasparente brillant / Laqués mats

Étagères :

Chêne thermo-traité / Fashion Wood / Chêne laqué mat / Laqués mats / Méla miné

-

Korpus:

Lackiert Bianco / Lackiert Titanio / Lackiert Nero trasparente glänzend / Matte Farben

Wandborde:

Thermo-Eiche / Fashion Wood / Eiche matte Farben / Matte Farben / Melamin

-

Материалы и варианты отделки

Каркас:

Крашенный bianco / Крашенный Titanio / Крашенный nero прозрачный глянцевый / Матовые цвета

Полки:

Дуб термочотто / Fashion wood / Дуб матовых цветов / Матовые цвета / Ламинированный

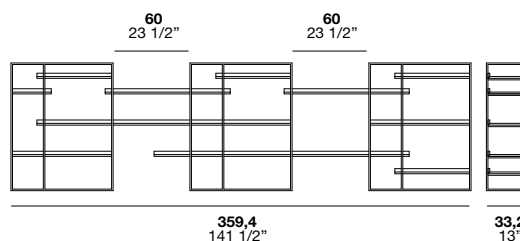
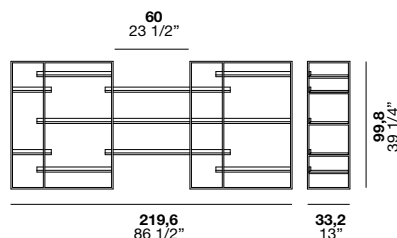
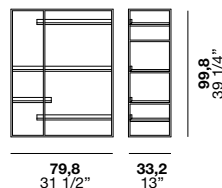





design R.D.A.

Materiali e finiture

Bordo: finitura Titanio

-

Materials and finishes

Edge: Titanium finish

-

Materiales y acabados

Canto: acabado Titanio

-

Matériaux et finitions

Bord : finition Titanio

-

Materialien und Ausführungen

Kante: Ausführung Titanio

-

Материалы и варианты отделки

Кромка: в отделке Титан

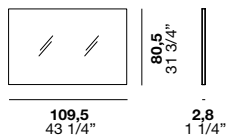



design R.D.A.

Materiali e finiture

Cornice:
verniciato Bianco, verniciato Moka
Shine, colori opachi

Materials and finishes

Frame:
Bianco painted, Moka Shine painted,
matt colours

Materiales y acabados

Cornisa:
barnizado Bianco, barnizado Moka
Shine, colores mate

Matériaux et finitions

Cadre :
verni Bianco, verni Moka Shine, laqués
mats

Materialien und Ausführungen

Rahmen:
lackiert Bianco, lackiert Moka Shine,
matte Farben

Материалы и варианты отделки

Рамка:
крашеный Bianco, крашеный Moka
Shine, матовые цвет

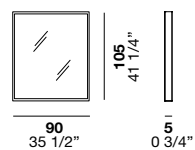
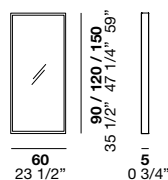
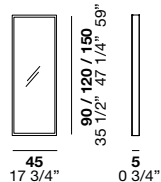

Perfetta abbinabilità con i moduli della
collezione Fil.

A perfect match for the Fil
collection units.

Perfecta compatibilidad con los
módulos de la colección Fil

Association parfaite avec les modules
de la collection Fil.

Perfekt kombinierbar mit den Modu-
len der Kollektion Fil.

Превосходная сочетаемость с
модулями коллекции Fil.





Haiku / Haiku Servomuto

design **Bruna Vaccher**

È un sistema semplice per riporre gli abiti velocemente, alloggiare gli accessori che ci accompagnano durante la giornata, mantenerne in ordine la stanza da letto. Disponibile nella versione a muro con lo specchio inserito o come semplice oggetto da centro stanza.

Haiku is a simple arrangement for quickly tidying clothes, storing your essential everyday accessories, and keeping your bedroom space clutter-free. Also available in a wall-mounted version with a mirror or as a simple centre piece for your bedroom.

Es un sistema sencillo para guardar rápidamente la ropa y los accesorios que nos acompañan durante el día, manteniendo el dormitorio ordenado. Disponible en versión de pared con el espejo integrado o como simple elemento de libre instalación.

C'est un système simple pour ranger les vêtements rapidement, loger les accessoires qui nous accompagnent pendant la journée, maintenir la chambre à coucher en ordre. Disponible dans la version murale avec le miroir inséré ou comme simple objet au centre de la pièce.

Ein einfaches System für die Aufbewahrung von Kleiderstücken und anderen Dingen, die uns den Tag über begleiten – so bleibt das Schlafzimmer immer aufgeräumt. Erhältlich in der Wandversion mit eingesetztem Spiegel oder in der einfachen Version zum Aufstellen im Raum.

Простая система для быстрого расположения одежды, аксессуаров, сопровождающих нас в течение дня, поддержания порядка спальни. Предусмотрена как в настенном варианте, так и с зеркалом, или просто как предмет, устанавливаемый по центру комнаты.

Materiali e finiture

Struttura:

Verniciato Moka Shine

Ripiani:

Fashion wood / Rovere laccati opachi / Laccati opachi e lucidi / Nobilitati

Materials and finishes

Frame:

Painted Moka Shine

Shelves:

Fashion Wood / matt lacquered oak / matt and high-gloss lacquer/ surface finishes

Materiales y acabados

Estructura:

Barnizado Moka Shine

Baldas:

Fashion wood / Roble lacados mate / Lacados mate y brillantes / Ennoblecidos

Matériaux et finitions

Structure :

Verni Moka Shine

Étagères :

Fashion wood / Chêne laqué mat / Laqués mats et brillants / Mé laminés

Materialien und Ausführungen

Korpus:

Lackiert Moka Shine

Fachböden:

Fashion Wood / Eiche matt lackiert / matt und glänzend lackiert / Melamin

Материалы и варианты отделки

Каркас:

Крашенный Moka Shine

Полки:

Fashion wood / Дуб крашенный матовый / Крашенный матовый и глянцевый / Ламинированный

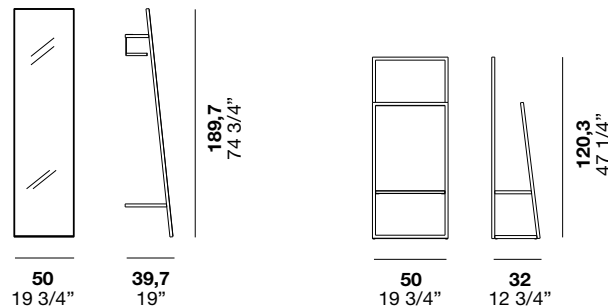



Quadrata / Rettangolare

design R.D.A.

Materiali e finiture

Specchio

-

Materials and finishes

Mirrors

-

Materiales y acabados

Espejo

-

Matériaux et finitions

Miroir

-

Materialien und Ausführungen

Spiegel

-

Материалы и варианты отделки

Зеркало

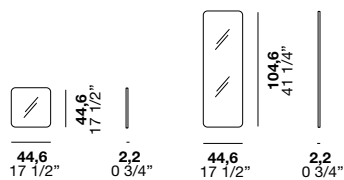





Allen

ALLEN

.....
letto / bed





Letto imbottito e sfoderabile caratterizzato da una testiera di altezza generosa con piacevole cucitura a motivo esagonale. Ampia la scelta di misure, anche con contenitore.

Padded bed with removable cover and a high headboard featuring hexagonal stitching. There are a wide range of sizes available, including with storage possibilities.

Cama tapizada y desenfundable caracterizada por una cabecera de gran altura con una bella costura de patrón hexagonal. Amplia selección de medidas, incluso con contenedor.

Lit rembourré et déhoussable caractérisé par une tête de lit d'une hauteur généreuse avec une agréable couture aux motifs hexagonaux. Ample choix de dimensions, même avec coffre.

Polsterbett mit abnehmbarem Bezug mit einem hohen Kopfteil, das mit Ziernähten mit einem Rautenmotiv verziert ist. Große Auswahl bei Maßen, auch mit Bettkasten.

Кровать со сменной обивкой отличается высокой головной спинкой с приятным швом с шестиугольным орнаментом. Широкий выбор размеров, а также вариант с контейнером.

Misure / Measurements / Medidas / Dimensions / Maße / Размеры

Vano rete / Inner spring support size / Compartimento somier / Logement sommier / Lattenrostaufnahme / Пром под сетку

L116	P215	H129	90,5 x 202
L146	P215	H129	120,5 x 202
L166	P215	H129	140,5 x 202
L177,5	P215	H129	152 x 202
L180,5	P220	H129	155 x 207
L186	P215	H129	160,5 x 202
L206	P215	H129	180,5 x 202
L212,5	P232	H129	187 x 219
L220,5	P220	H129	195 x 207

Disponibile anche con contenitore / Also available with storage unit / Disponible también con contenedor / Également disponible avec coffre / Erhältlich auch mit Bettkasten / Предусмотрен вариант с контейнером

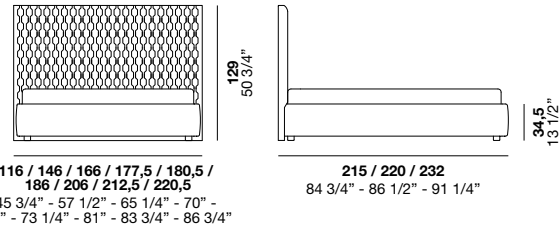



Aren

AREN

.....
letto / bed





Aren

design R.D.A.

Morbido ma rigoroso allo stesso tempo, Aren si distingue nei particolari, come la cucitura al centro della testiera e le rifiniture laterali con bottoni. Ampia la scelta di misure, anche con contenitore.

Soft yet sleek, Aren features numerous details such as the stitching in the centre of the headboard and buttons on the sides. It is available in a range of sizes, including with storage possibilities.

Mullida y rigurosa al mismo tiempo, Aren se distingue por sus detalles, como la costura en el centro de la cabecera y los remates laterales con botones. Disponible en una amplia selección de medidas, incluso con contenedor.

Moelleux mais rigoureux à la fois, Aren se distingue pour ses détails, comme la couture au centre de la tête de lit et les finitions latérales avec boutons. Ample choix de dimensions, même avec coffre.

Weich und streng zur gleichen Zeit: Aren überzeugt mit besonderen Details wie der Naht in der Mitte des Kopfteils und den Knopfverzierungen an den Seiten. Große Auswahl bei Maßen, auch mit Bettkasten.

Мягкая, но в то же время строгая кровать Aren отличается в деталях, таких как шов в центре головной спинки и боковые отделки пуговицами. Широкий выбор размеров, а также вариант с контейнером.

Misure / Measurements / Medidas / Dimensions / Maße / Размеры

Vano rete / Inner spring support size / Compartimento somier / Logement sommier / Lattenrostaufnahme / Промем под сетку

L116	P213	H106	90,5 x 202
L146	P213	H106	120,5 x 202
L166	P213	H106	140,5 x 202
L177,5	P213	H106	152 x 202
L180,5	P218	H106	155 x 207
L186	P213	H106	160,5 x 202
L206	P213	H106	180,5 x 202
L212,5	P230	H106	187 x 219
L220,5	P218	H106	195 x 207

Disponibile anche con contenitore / Also available with storage unit / Disponible también con contenedor / Également disponible avec coffre / Erhältlich auch mit Bettkasten / Предусмотрен вариант с контейнером

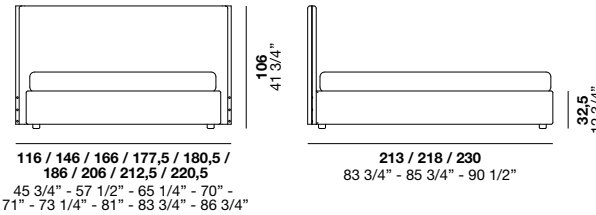



Aston

ASTON

.....
letto / bed



Aston letto / bed	L180 P215 H128
Timeless comodino /night stand	L60 P45 H36
Timeless comodino /night stand	L45 P45 H43,7
Timeless comò /dresser	L145 P55 H70



Aston fa della linearità delle forme la sua carta vincente. Imbottito e sfoderabile è disponibile in un vasta gamma di rivestimenti in tessuto, ecopelle e pelle. Ampia la scelta di misure, anche con contenitore.

Aston's main asset is its linear shape. Padded and with a removable cover, this piece is available in a vast array of fabric and leather upholstery. It comes in a range of sizes, including with storage possibilities.

Aston hace de la linealidad formal su carta ganadora. Tapizada y desfundable, se ofrece en una enorme gama de revestimientos de tejido, eco-piel y piel. Disponible en una amplia selección de medidas, incluso con contenedor.

Aston fait de la linéarité des formes son point fort. Rembourré et déhoussable, il est disponible dans une vaste gamme de revêtements en tissu, éco-cuir et cuir. Ample choix de dimensions, même avec coffre.

Bei Aston sind seine linearen Formen Trumpf: Ein Polsterbett mit abnehmbaren Bezug und einer breiten Auswahl von Stoff-, Kunstleder- und Lederbezügen. Große Auswahl bei Maßen, auch mit Bettkasten.

Выигрышной картой Aston является прямолинейность ее форм. Предлагается широкий ассортимент ткани, экокожи и кожи для сменной обивки. Широкий выбор размеров, а также вариант с контейнером.

Misure / Measurements / Medidas / Dimensions / Maße / Размеры

Vano rete / Inner spring support size / Compartimento somier / Logement sommier / Lattenrostaufnahme / Проем под сетку

L110	P215	H128	90,5 x 202
L140	P215	H128	120,5 x 202
L160	P215	H128	140,5 x 202
L171,5	P215	H128	152 x 202
L174,5	P220	H128	155 x 207
L180	P215	H128	160,5 x 202
L200	P215	H128	180,5 x 202
L206,5	P232	H128	187 x 219
L214,5	P220	H128	195 x 207

Disponibile anche con contenitore / Also available with storage unit / Disponible también con contenedor / Également disponible avec coffre / Erhältlich auch mit Bettkasten / Предусмотрен вариант с контейнером

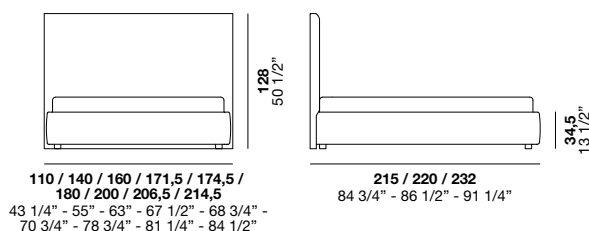



California letto / bed	L177 P230 H85,5
Fil moduli a sx /sf units	L120 P48 H35,6
Fil moduli a dx /rsf units	L135 P48 H37,6

California

CALIFORNIA

.....
letto / bed



California

design CO³ Design Studio

California è un letto imbottito disponibile in versione sommier o con piedini in metallo. Questo letto può essere arricchito di comode e funzionali testiere alzabili. Ampia la scelta di misure disponibili.

California is a padded bed available as a sofa bed or with metal feet. This bed can be enriched with comfortable, functional headboards that can be raised. A wide range of sizes are available.

California es una cama tapizada que se ofrece en versión con canapé o con patas de metal. Puede completarse con cabeceras elevables, que resultan cómodas y funcionales. Disponible en una amplia selección de medidas.

California est un lit disponible dans la version sommier ou avec pieds en métal. Ce lit peut être enrichi de pratiques et fonctionnelles têtes de lit relevables. Ample choix de dimensions disponibles.

California ist ein Polsterbett das als Boxspringbett oder mit Füßen aus Metall erhältlich ist. Dieses Bett kann mit bequemen und funktionellen verstellbaren Kopfteilen ausgestattet werden. Große Auswahl bei den erhältlichen Maßen.

California - это кровать с мягкой обивкой в версии софы или с металлическими ножками. Эта кровать может быть укомплектована удобной и функциональной подъемной головной спинкой. Широкий выбор предлагаемых размеров.

Misure / Measurements /
Medidas / Dimensions /
Мәре / Размеры

Vano rete / Inner spring support size /
Compartimento somier / Logement
sommier / Lattenrostaufnahme
/ Проем под сетку

L107	P230	H85,5	90,5 x 202
L137	P230	H85,5	120,5 x 202
L157	P230	H85,5	140,5 x 202
L168,5	P230	H85,5	152 x 202
L171,5	P235	H85,5	155 x 207
L177	P230	H85,5	160,5 x 202
L197	P230	H85,5	180,5 x 202
L203,5	P247	H85,5	187 x 219
L211,5	P235	H85,5	195 x 207

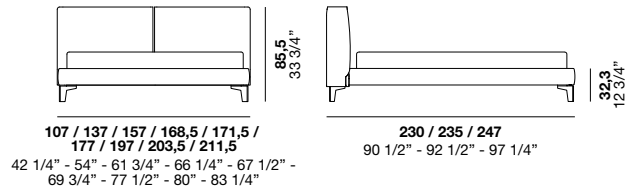



.....
California letto /bed L177 P230 H75
California tavolino /occasional table L60 P44 H38
California tavolino /occasional table L70 P44 H38
.....

California

design CO³ Design Studio

CALIFORNIA

**Misure / Measurements /
Medidas / Dimensions /
Мәре / Размеры**

**Vano rete / Inner spring support size /
Compartimento somier / Logement
sommier / Lattenrostaufnahme
/ Проём под сетку**

L107	P230	H75	90,5 x 202
L137	P230	H75	120,5 x 202
L157	P230	H75	140,5 x 202
L168,5	P230	H75	152 x 202
L171,5	P235	H75	155 x 207
L177	P230	H75	160,5 x 202
L197	P230	H75	180,5 x 202
L203,5	P247	H75	187 x 219
L211,5	P235	H75	195 x 207

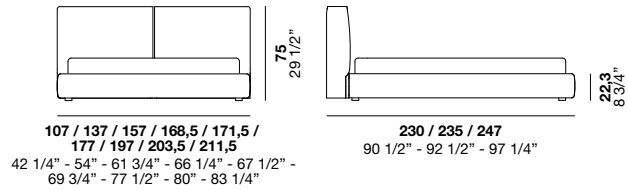

Alf DaFrè — STORAGE UNITS / BEDS



Clipper

CLIPPER

.....

letto / bed



Clipper letto / bed L181,5 P211 H96,3
 Rim comodino / night stand L40 P40 H52

Wok tavolino / occasional table L27,5 P27,5 H50
 Wok box tavolino / occasional table L35 P35 H43



Clipper

design CO³ Design Studio

Clipper è un letto con testiera e piattaforma in legno e piedi in metallo. La particolare stondatura degli angoli della piattaforma è ripresa con coerenza nella sagomatura del pannello testiera.

Clipper is a bed with a wooden headboard and platform and metal feet. The unique rounded angles on the platform are echoed in the cut of the headboard panel.

Clipper es una cama con cabecera y plataforma de madera y patas de metal. La particular forma redondeada de las esquinas de la plataforma se ve reproducida con coherencia en el perfil del panel de la cabecera.

Clipper est un lit avec tête de lit et encadrement en bois et pieds en métal. L'arrondissement particulier des angles de l'encadrement est repris avec cohérence dans le façonnage du panneau de la tête de lit.

Clipper ist ein Bett mit Kopfteil und Liegefläche aus Holz und Füßen aus Metall. Die auffallende Abrundung an den Ecken der Liegefläche werden von der Form der Kopfteilplatte wieder aufgenommen.

Clipper - это кровать с головной спинкой и платформой из дерева и металлическими ножками. Специальная закругленность углов платформы последовательно повторяется в фигурном профиле панели головной спинки.

Misure / Measurements /
Medidas / Dimensions /
Мәре / Размеры

L181,5 P211 H96,3

Vano rete / Inner spring support size /
Compartimento somier / Logement
sommier / Lattenrostaufnahme
/ Пром под сетку

160,5 x 200,5

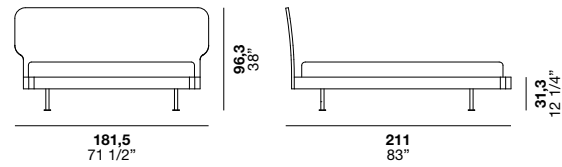



.....
Cloud letto /bed L170 P225,5 H93
Timeless comodino /night stand L60 P45 H36
Timeless settimanale /5 drw chest L60 P45 H110

Cloud

CLOUD

.....
letto / bed





Cloud

design CO³ Design Studio

I morbidi cuscini imbottiti di questo letto si abbinano perfettamente alla piattaforma con estremità curve e piedini in metallo. Cloud propone un'infinita scelta di abbinamenti tra rivestimenti, essenze e laccati creando soluzioni a misura di ogni ambiente.

The soft, padded cushions on this bed match the platform with curved edges and metal feet perfectly. Cloud is available in many different combinations of upholstery, wood grains and lacquered finishes to create solutions tailored to every space.

Los mullidos cojines tapizados de esta cama hacen juego perfectamente con la plataforma de extremos curvados y patas de metal. Cloud ofrece un sinfín de combinaciones entre revestimientos, maderas y lacados, para crear soluciones adaptadas a cada ambiente.

Les moelleux coussins rembourrés de ce lit s'associent parfaitement à l'encadrement avec les extrémités arrondies et les pieds en métal. Cloud propose un infini choix d'assortiments entre revêtements, bois et laqués en créant des solutions sur mesure pour chaque espace ambiant.

Die weichen Polsterkissen dieses Bettes passen perfekt zur Liegefläche und ihren ausfallenden Rundungen sowie zu den Füßen aus Metall. Cloud bietet mit seiner Auswahl an Bezügen und Ausführungen in Holzarten oder Farb-lackierungen unendliche Kombinationsmöglichkeiten, die zu jedem Ambiente passen.

Мягкие стеганные подушки этой кровати превосходно сочетаются с изогнутыми краями и металлическими ножками. Cloud предлагает бесчисленное число вариантов обивок, дерева и крашенных поверхностей, богатый выбор которых поможет создать индивидуальные решения для любого помещения.

Misure / Measurements /
Medidas / Dimensions /
Maße / Размеры

L170 P225,5 H93

Vano rete / Inner spring support size /
Compartimento somier / Logement
sommier / Lattenrostaufnahme
/ Проем под сетку

160,5 x 200,5

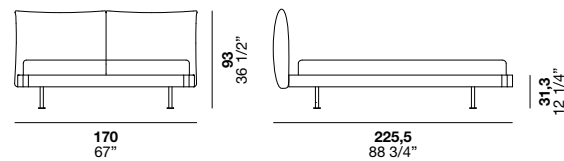



Da-Do letto /bed L173 P214,7 H93,7
Segno comodino /night stand L58,4 P45 H38,7

Da-Do

DA-DO

.....
letto / bed





Da-Do

design **Bruna Vaccher**

DA-DO

Completa la collezione Da-Do notte, integrando il gioco grafico dei diversi piani sulla testiera del letto. Il sistema consente l'uso di finiture diverse che giocano insieme legando il giro letto alla testiera. Disponibile anche versione con pannello testiera imbottito e rivestito in tessuto.

This bed completes the Da-Do bedroom collection, adding in a graphic effect with different surfaces on the headboard. Here you can use different finishes that work together, linking the bed frame to the headboard. Also available with a padded, upholstered headboard panel.

Completa la colección Da-Do noche, integrando el juego gráfico de las distintas superficies en la cabecera de la cama. El sistema permite utilizar acabados distintos que hacen juego uniendo el aro de la cama a la cabecera. Disponible también en versión con panel de cabecera tapizado y revestido de tejido

Il complète la collection Da-Do nuit, en intégrant le jeu graphique des différents plans sur la tête de lit. Le système permet l'utilisation de finitions différentes qui jouent ensemble en liant l'entourage du lit à la tête. Disponible également dans la version avec panneau tête de lit rembourré et revêtu en tissu.

Ergänzt die schlafzimmerkollektion Da-Do mit dem grafischen Muster auf den verschiedenen Ebenen des Kopfteils des Bettes. Bei diesem System können verschiedene Ausführungen so kombiniert werden, dass eine Verbindung zwischen Bettrahmen und Kopfteil entsteht. Auch mit gepolsterten Kopfteil oder einem Kopfteil mit Stoffbezug erhältlich.

Дополняет коллекцию спальня Da-Do, с игрой графики на различных уровнях головной спинки кровати. Система позволяет использовать различные варианты отделки, связывая периметр с головной спинкой. Также предусмотрена в варианте с панелью мягкой головной спинки и в тканевой обивке.

Misure / Measurements / Medidas / Dimensions / Maße / Размеры

P18

L 103	P 214,3	H 93,7	90,5 X 200,5
L 133	P 214,3	H 93,7	120,5 X 200,5
L 153	P 214,3	H 93,7	140,5 X 200,5
L 164,6	P 214,7	H 93,7	152 X 200,5
L 173	P 214,7	H 93,7	160,5 X 200,5
L 193	P 214,7	H 93,7	180,5 X 200,5
L 167,6	P 219,2	H 93,7	155 X 200,5
L 199,6	P 232,2	H 93,7	187 X 218
L 207,6	P 219,2	H 93,7	195 X 205

Vano rete / Inner spring support size / Compartimento somier / Logement sommier / Lattenrostaufnahme / Проем под сетку

Misure / Measurements / Medidas / Dimensions / Maße / Размеры

P24

L 103	P 214,3	H 93,7	90,5 X 200,5
L 133	P 214,3	H 93,7	120,5 X 200,5
L 153	P 214,3	H 93,7	140,5 X 200,5
L 164,6	P 214,7	H 93,7	152 X 200,5
L 173	P 214,7	H 93,7	160,5 X 200,5
L 193	P 214,7	H 93,7	180,5 X 200,5
L 167,6	P 219,2	H 93,7	155 X 200,5
L 199,6	P 232,2	H 93,7	187 X 218
L 207,6	P 219,2	H 93,7	195 X 205

Vano rete / Inner spring support size / Compartimento somier / Logement sommier / Lattenrostaufnahme / Проем под сетку

Disponibile anche con contenitore / Also available with storage unit / Disponible también con contenedor / Également disponible avec coffre / Erhältlich auch mit Bettkasten / Предусмотрен вариант с контейнером

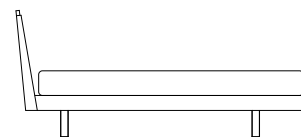
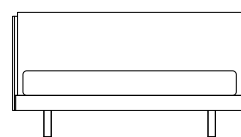

103 / 133 / 153 / 164,6 / 173 / 193 / 167,6 / 199,6 / 207,6
40 1/2" - 52 1/2" - 60 1/4" - 64 3/4" - 68" - 76" - 66" - 78 1/2" - 81 3/4"

214,3 / 214,7 / 219,2 / 232,2
84 1/2" - 84 1/2" - 86 1/4" - 91 1/2"

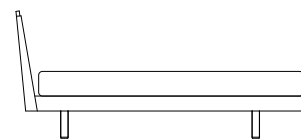
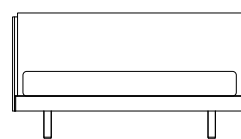

103 / 133 / 153 / 164,6 / 173 / 193 / 167,6 / 199,6 / 207,6
40 1/2" - 52 1/2" - 60 1/4" - 64 3/4" - 68" - 76" - 66" - 78 1/2" - 81 3/4"

214,3 / 214,7 / 219,2 / 232,2
84 1/2" - 84 1/2" - 86 1/4" - 91 1/2"



Alf DaFrè — STORAGE UNITS / BEDS



.....
Dorian letto / bed L180 P228,4 H96,6
Rim comodino / night stand L40 P40 H52
Da-do system composizione comò / dresser composition L90 P45 H101,7
.....

Dorian

DORIAN

.....
letto / bed





Dorian

design **Haften Studio**

L'ispirazione è il recupero delle forme retro dei letti di memoria, dalle linee sottili e dalla struttura quasi evanescente. Ma il tocco di spessori nella finitura della testata, nel disegno delle gambe e nella curvatura elegante di tutti gli elementi, lo rendono un vero pezzo di alto valore, che può essere arricchito da morbidi cuscini per la testata. Ampia la scelta di misure disponibili.

This piece is inspired by and reminiscent of the retro shapes of beds of times past, with thin lines and a structure that almost fades into the distance. The contrasting thickness in the headboard finish, leg design and omnipresent elegant curves make it a high-value piece, which can be embellished with soft headboard cushions. A wide range of sizes are available.

Este modelo se inspira en la recuperación de las formas retro de las camas del pasado, con líneas esbeltas y una estructura que parece desvanecerse. Pero el toque de los espesores en el acabado de la cabecera, en el dibujo de las patas y en la elegante curvatura de todos los elementos la convierten en una auténtico objeto de valor que se puede completar con mullidos cojines para la cabecera. Disponible en una amplia selección de medidas.

L'inspiration est la récupération des formes rétro des lits de mémoire, aux lignes fines et à la structure presque évanescence. Mais la touche des épaisseurs dans la finition de la tête de lit, dans le dessin des pieds et dans la courbure élégante de tous les éléments font de ce lit une véritable pièce de grande valeur, qui peut être enrichie par de moelleux coussins pour la tête de lit. Ample choix de dimensions disponibles.

Die Inspiration liegt in der Wiederaufnahme der traditionellen Formsprache der Retro-Betten, die sich durch eine zarte Linienführung und einen schlanken Korpus auszeichnen. Aber die kunstvollen Verjüngungen am Kopfteil und bei den Beinen sowie die eleganten Kurvenformen aller Elemente machen aus diesem Bett ein echtes Schmuckstück, das mit weichen Kissen für den Kopfteil bereichert werden kann. Große Auswahl bei den erhältlichen Maßen.

Вдохновляющим является возврат кровати к формам в стиле ретро, с тонкими линиями и с почти ускользящим каркасом. Но штрих солидности в отделке головной спинки, в дизайне ножек и элегантных изгибах всех элементов делают эту кровать действительно ценной вещью, которая может быть также украшена мягкими подушками для головной спинки. Широкий выбор предлагаемых размеров.

Misure / Measurements / Medidas / Dimensioens / Maße / Размеры

L140	P219,2	H94
L160	P219,2	H94
L171,4	P219,2	H94
L174,4	P223,6	H94
L180	P219,2	H94
L200	P219,2	H94
L206,4	P236,6	H94
L214,4	P223,6	H94

Vano rete / Inner spring support size / Compartimento somier / Logement sommier / Lattenrostaufnahme / Проем под сетку

120,5 x 200,5
140,5 x 200,5
152,5 x 200,5
155 x 205
160,5 x 200,5
180,5 x 200,5
187 x 218
195 x 205

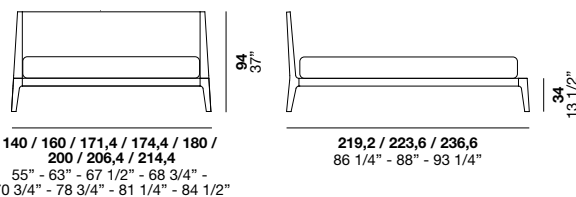

Misure / Measurements / Medidas / Dimensioens / Maße / Размеры

L140	P228,4	H96,6
L160	P228,4	H96,6
L171,4	P228,4	H96,6
L174,4	P232,8	H96,6
L180	P228,4	H96,6
L200	P228,4	H96,6
L206,4	P245,9	H96,6
L214,4	P232,8	H96,6

Vano rete / Inner spring support size / Compartimento somier / Logement sommier / Lattenrostaufnahme / Проем под сетку

120,5 x 200,5
140,5 x 200,5
152,5 x 200,5
155 x 205
160,5 x 200,5
180,5 x 200,5
187 x 218
195 x 205

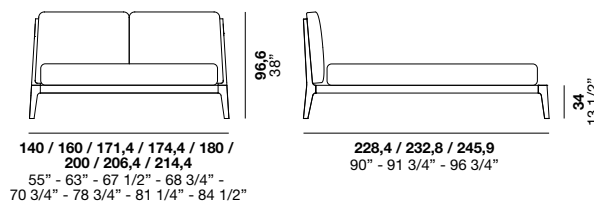



Francis

FRANCIS

.....
letto / bed

Francis letto / bed L190 P220 H112
Linea comodino / night stand L64 P53 H27

Domino* modulo / module L48 P28,3 H48
Linea comò / dresser L128 P53 H73

*Per questo articolo vedi "Complementi" - Il senso dei dettagli
*For this article see "Complements" - A sense of detail



Francis letto /bed	L190 P219 H115
Fil moduli a sx /lsf units	L60 P48 H17,8
Fil moduli a dx /rsf units	L150 P48 H53,4

Francis

design R.D.A. / Haften Studio

Un letto imbottito morbido e rassicurante caratterizzato da una testata avvolgente arricchita da cuciture a vista in contrasto. Due le versioni disponibili, sommier o piattaforma con piedini in metallo, tante le misure, anche con contenitore.

A soft and comforting upholstered bed with an enveloping headboard decorated with visible contrast stitching. It is available in two different versions: either as sofa bed or with a platform and metal feet. It comes in a variety of sizes, including with storage possibilities.

Una cama tapizada mullida y reconfortante que se caracteriza por una amplia cabecera decorada con costuras a la vista en contraste. Hay dos versiones disponibles: canapé o plataforma con patas de metal; disponible en muchas medidas, incluso con contenedor.

Un lit rembourré moelleux et rassurant caractérisé par une tête de lit enveloppante enrichie par des coutures apparentes en contraste. Les versions disponibles sont deux, sommier ou encadrement avec pieds en métal, et nombreuses sont les dimensions, même avec coffre.

Ein weiches und gemütliches Polsterbett mit einem faszinierenden Kopfteil mit Sichtnähten in Kontrastfarben. Es sind zwei Versionen erhältlich: Boxspringbett oder Liegefläche mit Füßen aus Metall. Große Auswahl bei Maßen, auch mit Bettkasten.

Мягкая и успокаивающая кровать с обивкой отличается изумительной головной спинкой, декорированной видимым контрастным швом. Две предлагаемые версии кровати - сомье или на платформе с металлическими ножками, множество размеров, а также возможность комплектации контейнером.

Misure / Measurements / Medidas / Dimensions / Maße / Размеры

Vano rete / Inner spring support size / Compartimento somier / Logement sommier / Lattenrostaufnahme / Проем под сетку

L120	P219	H115	90,5 x 202
L150	P219	H115	120,5 x 202
L170	P219	H115	140,5 x 202
L181,5	P219	H115	152 x 202
L184,5	P224	H115	155 x 207
L190	P219	H115	160,5 x 202
L210	P219	H115	180,5 x 202
L216,5	P236	H115	187 x 219
L224,5	P224	H115	195 x 207

Disponibile anche con contenitore / Also available with storage unit / Disponible también con contenedor / Également disponible avec coffre / Erhältlich auch mit Bettkasten / Предусмотрен вариант с контейнером

Misure / Measurements / Medidas / Dimensions / Maße / Размеры

Vano rete / Inner spring support size / Compartimento somier / Logement sommier / Lattenrostaufnahme / Проем под сетку

L120	P220	H112	90,5 x 202
L150	P220	H112	120,5 x 202
L170	P220	H112	140,5 x 202
L181,5	P220	H112	152 x 202
L184,5	P225	H112	155 x 207
L190	P220	H112	160,5 x 202
L210	P220	H112	180,5 x 202
L216,5	P237	H112	187 x 219
L224,5	P225	H112	195 x 207

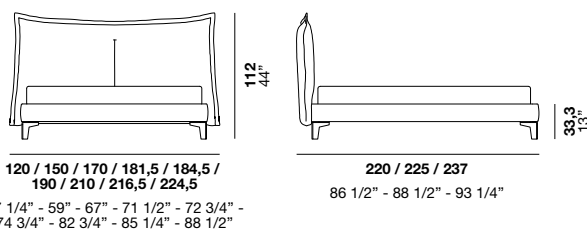
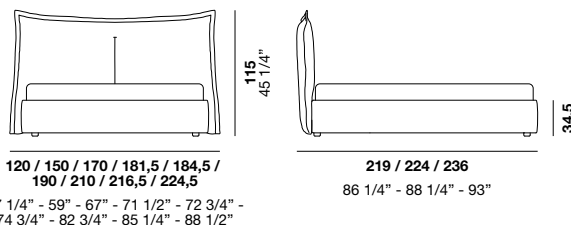



.....
Jetty letto /bed **L174 P212,2 H94,5**
Rim comodino /night stand **L40 P40 H52**

Jetty

JETTY

.....
letto / bed







Jetty letto /bed	L174 P212,2 H94,5
Rim comodino /night stand	L40 P40 H52



Jetty letto /bed **L174 P212,2 H94,5**





I letti "matrimoniali" con telaio in acciaio nascono dall'idea di una semplice struttura a sbalzo per far sembrare che il letto galleggi sul pavimento. Il pannello della testiera imbottito crea un angolo confortevole con il telaio del letto per essere osato come un poggiaschiena. Disponibile anche nella versione con base contenitore imbottita incorporata nel telaio in acciaio. Testiera in Cuoio e nella versione con giroletto, tessuto abbinato.

The design for this double bed with a steel frame came from the idea of a simple cantilever-style structure, to make the bed seemingly float above the ground. The padded headboard panel creates a comfortable back rest supported by the bed frame. Also available with a padded storage base integrated into the steel frame. Headboard in leather; matching upholstery for the model with full bed frame.

Las camas "de matrimonio" con armazón de acero nacen de la idea de una sencilla estructura en voladizo para dar la sensación de que la cama flota sobre el suelo. El panel tapizado de la cabecera crea un cómodo ángulo con el armazón de la cama, para poder utilizarlo como respaldo. Disponible también en la versión con base contenedor tapizada, incorporada en el armazón de acero. Cabecera de cuero y, en la versión con aro, tejido a juego.

Les lits « deux places » avec cadre en acier naissent d'une idée d'une structure simple en saillie pour donner l'impression que le lit flotte sur le sol. Le panneau de la tête de lit rembourré crée un angle confortable avec le cadre du lit pour être utilisé comme dossier. Disponible également dans la version avec base de rangement rembourrée et incorporée dans le cadre en acier. Tête de lit en Cuir et dans la version avec entourage, tissu assorti.

Das schlichte Design dieses Doppelbetts mit einem Gestell aus Stahl sorgt dafür, dass das Bett auf dem Fußboden zu schweben scheint. Die gepolsterte Kopfteilplatte ist angenehm angeschrägt und wird so zu einer bequemen Rückenlehne. Auch in der Version mit einem gepolsterten Bettkasten erhältlich, der im Stahlgestell integriert ist. Kopfteil aus Leder oder in der Version mit Betteinfassung, mit passendem Stoff.

"Двуспальные" кровати со стальным каркасом появились от идеи простой структуры "со смещением" так, чтобы кровать парит в воздухе. Панель мягкой головной панели образует удобный угловой элемент с каркасом кровати, который может использоваться как опора для спины. Также предусмотрена в варианте с мягким контейнером тумбой, встроенным в стальной каркас. Головная спинка из кожи и с периметром, в сочетании с тканью.

Misure / Measurements / Medidas / Dimensions / Maße / Размеры

L 174 P 212,2 H 94,5

Vano rete / Inner spring support size / Compartimento somier / Logement sommier / Lattenrostaufnahme / Пром под сетку

160,5 X 200,5

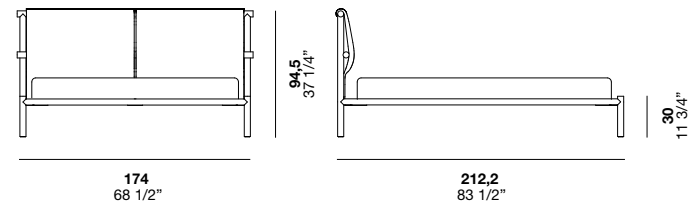

Misure / Measurements / Medidas / Dimensions / Maße / Размеры

L 174 P 212,9 H 94,5

Vano rete / Inner spring support size / Compartimento somier / Logement sommier / Lattenrostaufnahme / Пром под сетку

160,5 X 202

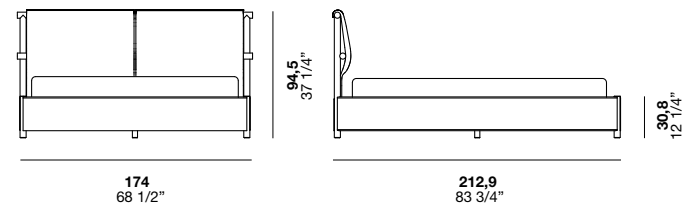

Disponibile anche con contenitore / Also available with storage unit / Disponible también con contenedor / Également disponible avec coffre / Erhältlich auch mit Bettkasten / Предусмотрен вариант с контейнером



Jordy

JORDY

.....
letto / bed

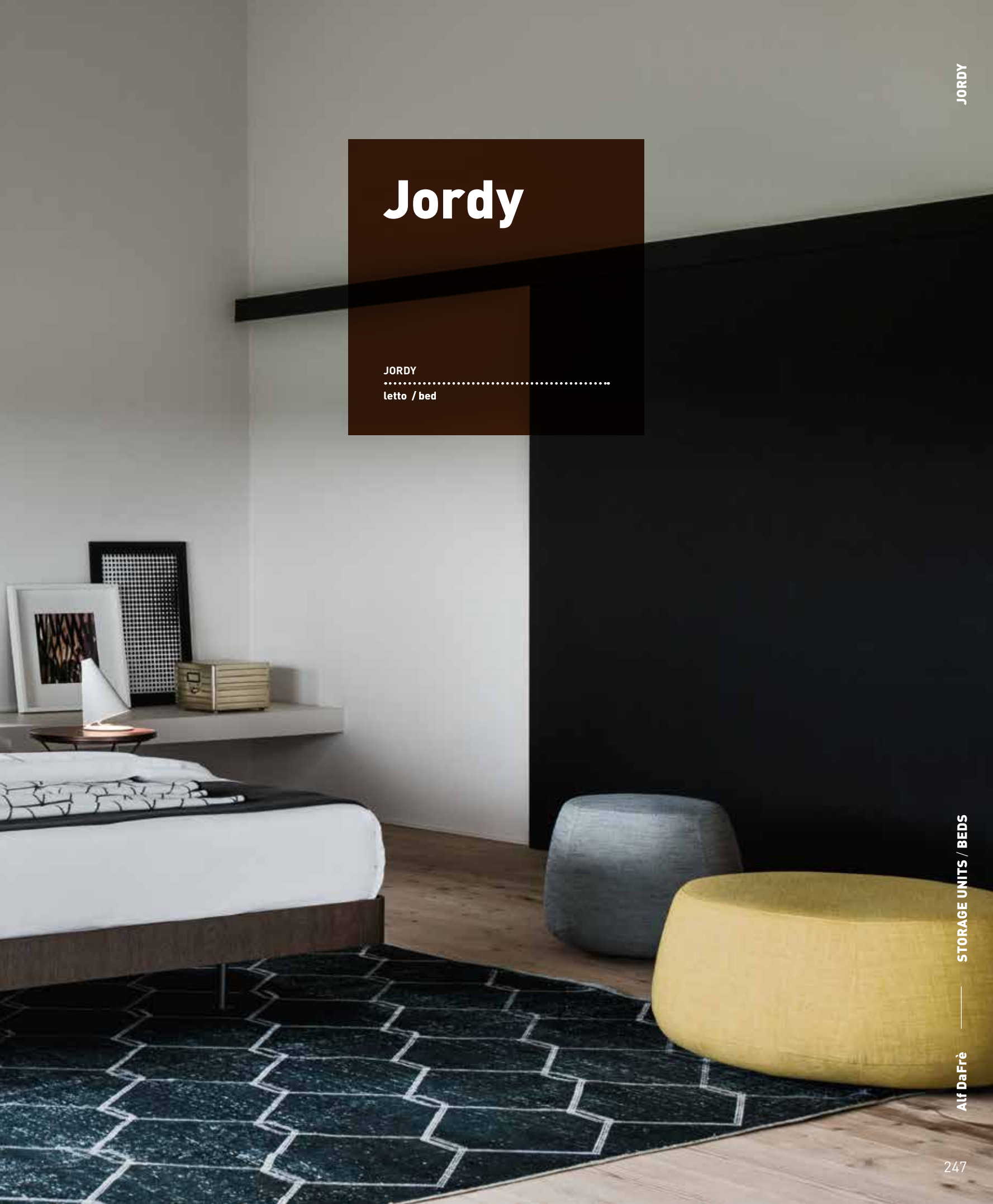





.....
Jordy letto /bed **L165,5 P216,4 H101,8**
Life tavolino /occasional table **L55 P45 H42**



Jordy letto /bed L165,5 P216,4 H101,8
Timless comodino /night stand L60 P45 H30,9





Jordy

design **Enrico cesana**

Jordy, un letto che unisce il calore del legno alla morbidezza del tessuto, un perfetto equilibrio di proporzioni e materiali. Un prodotto dalla forte personalità in grado di adattarsi a tantissimi ambienti. La testiera tessile è studiata per adattarsi ai comportamenti delle persone, con un semplice gesto è possibile inclinarla migliorando il comfort e la postura per una comoda lettura oppure la visione di un film. Il risultato è un letto senza tempo, elegante e versatile.

Jordy, a bed that brings together the warm feel of wood and the soft comfort of a fabric finish, in a perfect balance of proportions and materials. This bold product adapts to suit a wide range of different spaces. The fabric headboard has been designed to adapt to you and your posture – with just one simple movement, you can incline the headboard to create a comfortable spot for reading or watching a film. The result is a timeless, elegant and versatile bed.

Jordy, una cama que combina la calidez de la madera con la suavidad del tejido, en un equilibrio perfecto de proporciones y materiales. Un producto de gran personalidad capaz de adaptarse a una infinidad de estilos. La cabecera en tejido está estudiada para amoldarse a los hábitos de las personas: se inclina con un simple gesto, mejorando el confort y la postura para leer con comodidad o ver una película. El resultado es una cama intemporal, elegante y versátil.

Jordy, un lit qui unit la chaleur du bois à la douceur du tissu, un équilibre parfait de proportions et de matériaux. Un produit à la forte personnalité en mesure de s'adapter à de nombreux espaces ambients. La tête de lit en tissu a été conçue pour s'adapter aux comportements des personnes, avec un simple de geste il est possible de l'incliner en améliorant le confort et la posture pour une lecture confortable ou bien pour la vision d'un film. Le résultat est un lit hors du temps, élégant et versatile.

Das Bett Jordy kombiniert die Wärme von Holz mit der weichen Textur von Stoff und schafft so die perfekte Balance aus Proportionen und Material. Ein Stück mit starkem Charakter, dass in vielen Ambiente eine gute Figur macht. Das Kopfteil aus Stoff lässt sich mit einem einfachen Handgriff in die gewünschte Position bringen, um bequem ein Buch zu lesen oder einen Film zu sehen. Ein zeitloses Bett, elegant und vielseitig.

Jordy, кровать, совмещающая тепло дерева с мягкостью ткани, превосходная сбалансированность пропорций и материалов. Характеризуется большим эффектом и способна адаптироваться к множеству вариантов интерьера. Головная спинка в тканевой отделке разработана для адаптации к поведению людей, ее легко можно наклонить, улучшая уровень комфорта и принимая положение для удобного чтения или просмотра фильма. Результат - элегантная и универсальная кровать, без временных границ.

Misure / Measurements /
Medidas / Dimensions /
Мәре / Размеры

L 165,5 P 216,4 H 101,8

Vano rete / Inner spring support size /
Compartimento somier / Logement
sommier / Lattenrostaufnahme
/ Проём под сетку

160,5 X 200,5

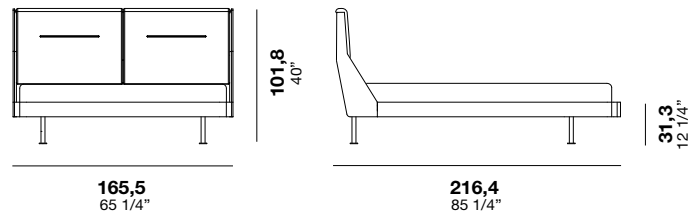



Leonard

LEONARD

.....
letto / bed



Leonard

design CO³ Design Studio

Leonard è un letto imbottito con una testiera fortemente caratterizzata dal motivo capitonné. Disponibile in un'ampia gamma di misure e rivestimenti, anche con contenitore.

Leonard is a padded bed with an upholstered high-impact headboard. It is available in a wide range of sizes and finishes, including with storage possibilities.

Leonard es una cama tapizada con cabecera fuertemente caracterizada por el patrón de capitonné. Disponible en una amplia gama de medidas y revestimientos, incluso con contenedor.

Leonard est un lit rembourré avec une tête de lit fortement caractérisée par le motif capitonné. Disponible dans une ample gamme de dimensions et revêtements, même avec coffre.

Leonard ist ein Polsterbett mit einem Kopfteil, das sich durch seine klassische Polsterung auszeichnet. Große Auswahl bei Maßen und Bezügen, auch mit Bettkasten.

Leonard - это кровать с мягкой обивкой и головной спинкой, характерным элементом которой является отделка капитоне. Предлагается в широкой гамме размеров и обивок, а также вариант с контейнером.

Misure / Measurements /
Medidas / Dimensions /
Maße / Размеры

Vano rete / Inner spring support size /
Compartimento somier / Logement
sommier / Lattenrostaufnahme
/ Проем под сетку

L110	P215	H128	90,5 x 202
L140	P215	H128	120,5 x 202
L160	P215	H128	140,5 x 202
L171,5	P215	H128	152 x 202
L174,5	P220	H128	155 x 207
L180	P215	H128	160,5 x 202
L200	P215	H128	180,5 x 202
L206,5	P232	H128	187 x 219
L214,5	P220	H128	195 x 207

Disponibile anche con contenitore / Also available with storage unit /
Disponible también con contenedor / Également disponible avec coffre /
Erhältlich auch mit Bettkasten / Предусмотрен вариант с контейнером

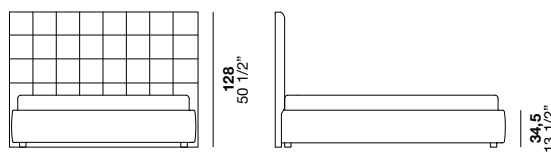

110 / 140 / 160 / 171,5 / 174,5 /
180 / 200 / 206,5 / 214,5
43 1/4" - 55" - 63" - 67 1/2" - 68 3/4" -
70 3/4" - 78 3/4" - 81 1/4" - 84 1/2"

215 / 220 / 232
84 3/4" - 86 1/2" - 91 1/4"



Milano

MILANO

.....
 letto / bed



.....	
Milano letto / bed	L184 P234,8 H94,3
Fil moduli a sx /lsf units	L60 P48 H36,9
Fil moduli a dx /rsf units	L60 P48 H29,8
.....	



Milano

design CO³ Design Studio

Dotato, nella versione pelle, di particolari cuciture "taglio al vivo" che ne delineano i contorni, Milano è un letto imbottito elegante e originale. I morbidi cuscini della testiera si "appoggiano" creando un piacevole gioco di livelli. Ampia la scelta di misure, anche con contenitore.

Featuring unusual, raw-cut stitching in the leather version which decorates the edging, the Milano padded bed is both elegant and original. The soft cushions appear to rest on the headboard, creating the effect of different levels. It is available in a range of sizes, including with storage possibilities.

Milano es una cama tapizada, elegante y original, que en la versión de piel presenta unas particulares costuras de "corte limpio" que delinear su contorno. Los mullidos cojines de la cabecera se "apoyan" creando un agradable juego de niveles. Disponible en una amplia selección de medidas, incluso con contenedor.

Équipé, dans la version cuir, de coutures particulières "coupe vive" qui en dessinent les contours, Milano est un lit rembourré élégant et original. Les moelleux coussins de la tête de lit s'"appuient" en créant un agréable jeu de niveaux. Ample choix de dimensions, même avec coffre.

Das elegante und originelle Polsterbett Milano zeichnet sich in der Lederversion durch die „unversäuberte“ Schnittnaht an den Konturen aus. Die weichen Kissen des Kopfteils liegen auf und sorgen für ein schönes Spiel mit Höhenunterschieden. Große Auswahl bei Maßen, auch mit Bettkasten.

Milano - elegante и оригинальная кровать с мягкой обивкой, имеющая в кожаной версии особые швы "на живую", которые очерчивают ее контуры. Мягкие подушки головной спинки "укладываются", создавая приятную игру уровней. Широкий выбор размеров, а также вариант с контейнером.

Misure / Measurements / Medidas / Dimensions / Maße / Размеры

L114	P234,8	H94,3	90,5 x 202
L144	P234,8	H94,3	120,5 x 202
L164	P234,8	H94,3	140,5 x 202
L175,4	P234,8	H94,3	152 x 202
L178,4	P239,8	H94,3	155 x 207
L184	P234,8	H94,3	160,5 x 202
L204	P234,8	H94,3	180,5 x 202
L210,4	P251,8	H94,3	187 x 219
L218,4	P239,8	H94,3	195 x 207

Vano rete / Inner spring support size / Compartimento somier / Logement sommier / Lattenrostaufnahme / Проем под сетку

90,5 x 202
120,5 x 202
140,5 x 202
152 x 202
155 x 207
160,5 x 202
180,5 x 202
187 x 219
195 x 207

Disponibile anche con contenitore / Also available with storage unit / Disponible también con contenedor / Également disponible avec coffre / Erhältlich auch mit Bettkasten / Предусмотрен вариант с контейнером

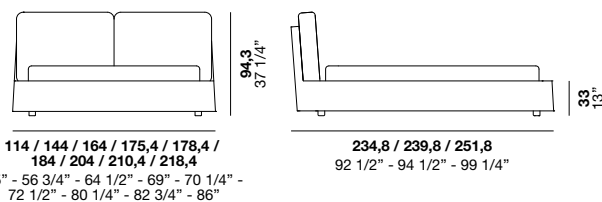



Morrison

MORRISON

.....
letto / bed







Morrison letto /bed	L197 P230 H92
Segno comodino /night stand	L58,4 P45 H38,7
Segno settimanale /4 drw chest	L58,4 P48 H131,7



Morrison letto /bed L197 P230 H92
Da-do system moduli a sx /lsf units L59 P45 H37,1

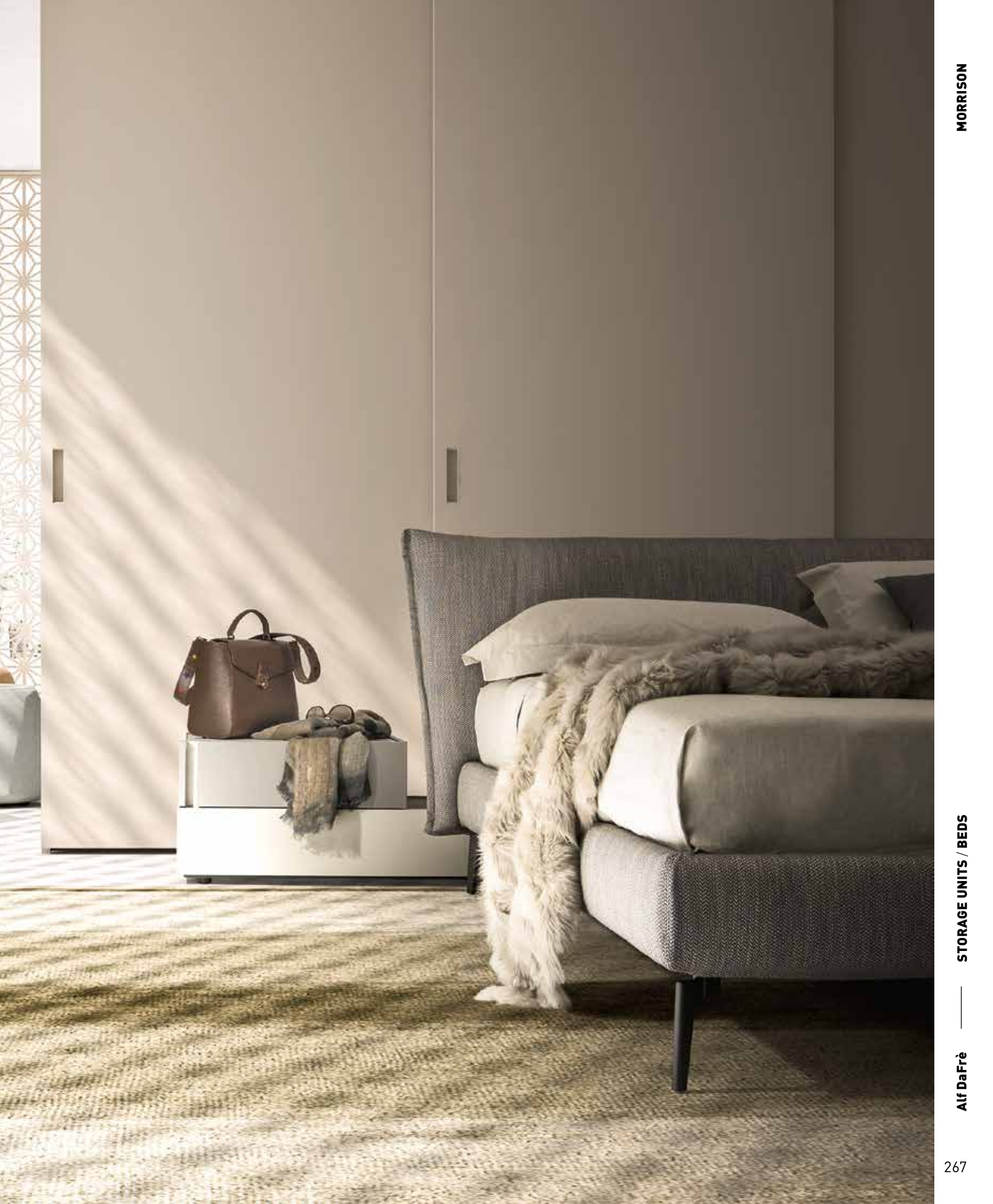



In questo letto le sezioni laterali leggermente inclinate della testiera portano lo sguardo al morbido rivestimento della parte centrale. Morrison dà libera scelta all'abbinamento tra il sommier o la piattaforma con piedini in metallo. Ampia la scelta di misure, anche con contenitore.

The slightly arched sides of the headboard on this bed lead the eye towards the soft upholstery of the central part. Morrison can be combined freely as a sofa bed or with a platform and metal feet. It is available in a range of sizes, including with storage possibilities.

En esta cama, las secciones laterales de la cabecera, levemente inclinadas, dirigen la mirada hacia el mullido revestimiento de la parte central. Morrison permite escoger libremente entre canapé o plataforma con patas de metal. Disponible en una amplia selección de medidas, incluso con contenedor.

Dans ce lit, les sections latérales légèrement inclinées de la tête de lit portent le regard sur le revêtement moelleux de la partie centrale. Morrison permet de choisir librement l'association entre le sommier ou l'encadrement avec pieds en métal. Ample choix de dimensions, même avec coffre.

Die leicht schrägen Seiten des Kopfteils rücken den weichen Bezug im mittleren Teil in den Mittelpunkt. Morrison ist je nach Wunsch als Boxspringbett oder mit Liegefläche mit Füßen aus Metall erhältlich. Große Auswahl bei Maßen, auch mit Bettkasten.

У этой кровати боковые слегка наклоненные секции головной спинки переводят взгляд на мягкую обивку центральной части. Morrison обеспечивает свободу выбора между сомье или платформой с металлическими ножками. Широкий выбор размеров, а также вариант с контейнером.

Misure / Measurements / Medidas / Dimensions / Maße / Размеры

Vano rete / Inner spring support size / Compartimento sommier / Logement sommier / Lattenrostaufnahme / Проем под сетку

L127	P229	H92	90,5 x 202
L157	P229	H92	120,5 x 202
L177	P229	H92	140,5 x 202
L188,5	P229	H92	152 x 202
L191,5	P234	H92	155 x 207
L197	P229	H92	160,5 x 202
L217	P229	H92	180,5 x 202
L223,5	P246	H92	187 x 219
L231,5	P234	H92	195 x 207

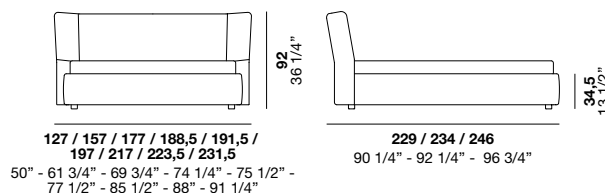

Disponibile anche con contenitore / Also available with storage unit / Disponible también con contenedor / Également disponible avec coffre / Erhältlich auch mit Bettkasten / Предусмотрен вариант с контейнером

Misure / Measurements / Medidas / Dimensions / Maße / Размеры

Vano rete / Inner spring support size / Compartimento sommier / Logement sommier / Lattenrostaufnahme / Проем под сетку

L127	P230	H92	90,5 x 202
L157	P230	H92	120,5 x 202
L177	P230	H92	140,5 x 202
L188,5	P230	H92	152 x 202
L191,5	P235	H92	155 x 207
L197	P230	H92	160,5 x 202
L217	P230	H92	180,5 x 202
L223,5	P247	H92	187 x 219
L231,5	P235	H92	195 x 207

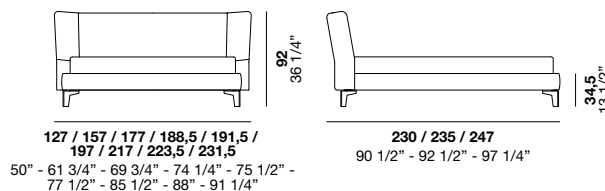



Oregon

OREGON

.....
letto / bed

.....
Oregon letto / bed L187 P255 H102
Twice comodino / night stand L64 P47,4 H44,4
Twice settimanale / 5drw chest L64 P47,4 H123,8



Oregon

design CO³ Design Studio

Oregon è un letto caratterizzato dalla particolare sagoma della testiera su due livelli che "abbraccia" la piattaforma. Una vasta scelta di misure e la possibilità del contenitore completano l'offerta di questo prodotto.

Oregon features an originally shaped headboard on two levels, which folds in to embrace the platform. This product is available in a vast range of sizes and a storage unit can be added.

Oregon es una cama caracterizada por el particular perfil de la cabecera en dos niveles, que "abraza" la plataforma. Una amplia selección de medidas y el contenedor opcional completan la oferta de este producto.

Oregon est un lit caractérisé par la forme particulière de la tête de lit sur deux niveaux qui "enlace" l'encadrement. Un vaste choix de dimensions et la possibilité du coffre complètent l'offre de ce produit.

Oregon ist ein Bett, das sich durch die besondere zweigeteilte Form seines Kopfteils auszeichnet, das die Liegefläche umrahmt. Eine große Auswahl bei den Maßen und ein Bettkasten komplettieren das Angebot.

Oregon - это кровать, отличающаяся особым двухуровневым контуром головной спинки, которая "охватывает" платформу. Широкий выбор размеров и возможность комплектации контейнером дополняют предложение этой модели.

Misure / Measurements /
Medidas / Dimensions /
Maße / Размеры

Vano rete / Inner spring support size /
Compartimento somier / Logement
sommier / Lattenrostaufnahme
/ Проем под сетку

L117	P225	H102	90,5 x 202
L147	P225	H102	120,5 x 202
L167	P225	H102	140,5 x 202
L178,5	P225	H102	152 x 202
L181,5	P230	H102	155 x 207
L187	P225	H102	160,5 x 202
L207	P225	H102	180,5 x 202
L213,5	P242	H102	187 x 219
L221,5	P230	H102	195 x 207

Disponibile anche con contenitore / Also available with storage unit /
Disponibile también con contenedor / Également disponible avec coffre /
Erhältlich auch mit Bettkasten / Предусмотрен вариант с контейнером

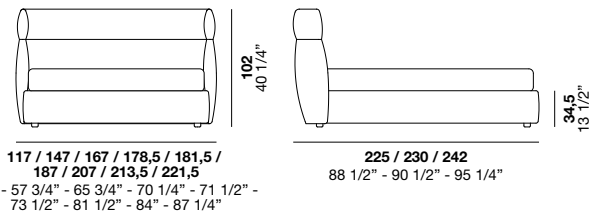



.....
Ralph letto /bedL173,5 P224 H112,6
Denny pouf /poufL142 P55 H42

Ralph

RALPH

.....
letto / bed



Ralph letto /bed	L173,5 P224 H112,6
Rim comodino /night stand	L40 P40 H52
Tuft tavolino /occasional table	L40,3 P40,3 H46,3
Tuft tavolino /occasional table	L60,3 P60,3 H36,8





Ralph

design **Bruna Vaccher**

RALPH

Linee intramontabili per il letto imbottito che stupisce nei particolari con diverse cuciture disponibili. Ampia gamma di misure disponibili, anche con contenitore.

The eternal shape of this padded bed is combined with unexpected detailing in the form of the available stitching options. It comes in a wide range of sizes, including with storage possibilities.

Formas imperecederas para la cama tapizada que sorprende por sus detalles con diversas costuras disponibles. Disponible en una amplia selección de medidas, incluso con contenedor.

Lignes hors du temps pour le lit rembourré qui surprend dans ses détails avec différentes coutures disponibles. Ample gamme de dimensions disponibles, même avec coffre.

Ein Polsterbett mit zeitlosen Linien, das mit Details überrascht: eine Auswahl von erhältlichen Nähten. Große Auswahl bei Maßen, auch mit Bettkasten.

Непреходящие линии для кровати с мягкой обивкой, которая изумляет в деталях, предлагаемых с различными швами. Предлагается в широкой гамме размеров, а также вариант с контейнером.

Misure / Measurements /
Medidas / Dimensions /
Maße / Размеры

Vano rete / Inner spring support size /
Compartimento somier / Logement
sommier / Lattenrostaufnahme
/ Проём под сетку

L103,5	P224	H112,6	90,5 x 202
L133,5	P224	H112,6	120,5 x 202
L153,5	P224	H112,6	140,5 x 202
L165	P224	H112,6	152 x 202
L168	P229	H112,6	155 x 207
L173,5	P224	H112,6	160,5 x 202
L193,5	P224	H112,6	180,5 x 202
L200	P241	H112,6	187 x 219
L208	P229	H112,6	195 x 207

Disponibile anche con contenitore / Also available with storage unit /
Disponibile también con contenedor / Également disponible avec coffre /
Erhältlich auch mit Bettkasten / Предусмотрен вариант с контейнером

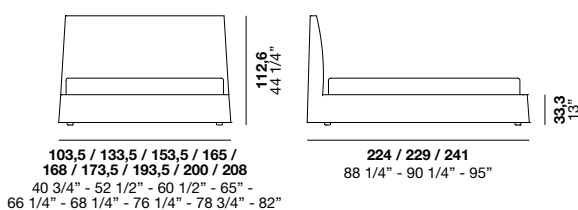

STORAGE UNITS / BEDS

Alf DaFrè



Skip

SKIP

.....
letto / bed





.....
Skip letto /bedL198 P214 H98,2
Hit tavolino /occasional table L38 P38,6 H50

.....
Hobby comodino /night stand L55,7 P44 H42

In assoluta armonia, pannelli in legno o rivestiti creano un gioco asimmetrico che dà valore visivo alla testata.

Con piattaforma legno o imbottita SKIP soddisfa ogni esigenza. Ampia la scelta di misure, anche con contenitore.

Blending together, these wooden or coated panels create an asymmetrical effect which gives the headboard great visual impact. With a wooden platform or padded, SKIP is designed to suit every need. It is available in a range of sizes, including with storage possibilities.

Con una total armonía, los paneles de madera o revestidos crean un juego asimétrico que añade valor visual a la cabecera. Con plataforma de madera o tapizada SKIP, satisface cualquier necesidad. Disponible en una amplia selección de medidas, incluso con contenedor.

En harmonie absolue, des panneaux en bois ou revêtus créent un jeu asymétrique qui donne une valeur visuelle à la tête de lit. Avec encadrement en bois ou rembourré SKIP satisfait chaque exigence. Ample choix de dimensions, même avec coffre.

Die absolute Harmonie: Holzplatten oder gepolsterte Platten schaffen ein asymmetrisches Spiel, das das Design des Kopfteils bereichert. Skip passt sich mit seiner Liegefläche aus Holz oder der gepolsterten Liegefläche jedem Anspruch an. Große Auswahl bei Maßen, auch mit Bettkasten.

Демонстрируя полную гармонию, панели из дерева или с обивкой создают ассиметричную игру, которая придает головной спинке изумительный внешний вид. С платформой из дерева или с обивкой SKIP удовлетворяет любым требованиям. Широкий выбор размеров, а также вариант с контейнером.

Misure / Measurements / Medidas / Dimensions / Maße / Размеры

L149,3	P214	H98,2
L179,3	P214	H98,2
L199,3	P214	H98,2

Vano rete / Inner spring support size / Compartimento somier / Logement sommier / Lattenrostaufnahme / Пром под сетку

90,5 x 200,5
120,5 x 200,5
140,5 x 200,5

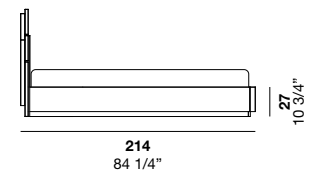
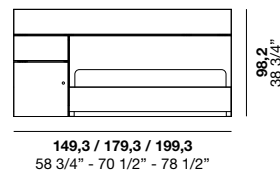
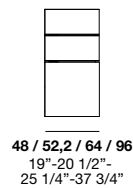

Misure / Measurements / Medidas / Dimensions / Maße / Размеры

L165,3	P214	H98,2
L195,3	P214	H98,2
L215,3	P214	H98,2

Vano rete / Inner spring support size / Compartimento somier / Logement sommier / Lattenrostaufnahme / Пром под сетку

90,5 x 200,5
120,5 x 200,5
140,5 x 200,5

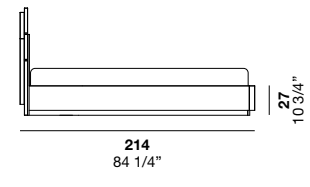
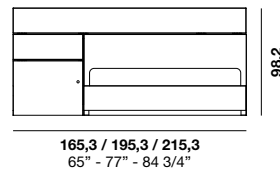
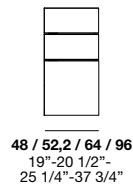

Misure / Measurements / Medidas / Dimensions / Maße / Размеры

L198	P214	H98,2
L228	P214	H98,2
L248	P214	H98,2
L259,6	P214	H98,2
L262,6	P218,5	H98,2
L268	P214	H98,2
L288	P214	H98,2
L294,6	P231,5	H98,2
L302,6	P218,5	H98,2

Vano rete / Inner spring support size / Compartimento somier / Logement sommier / Lattenrostaufnahme / Пром под сетку

90,5 x 200,5
120,5 x 200,5
140,5 x 200,5
152 x 200,5
155 x 205
160,5 x 200,5
180,5 x 200,5
187 x 218
195 x 205

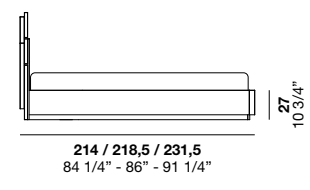
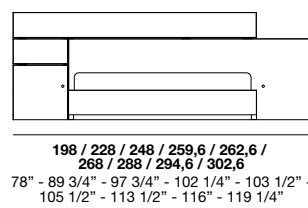
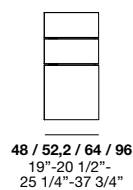

Misure / Measurements / Medidas / Dimensions / Maße / Размеры

L230	P214	H98,2
L260	P214	H98,2
L280	P214	H98,2
L291,6	P214	H98,2
L294,6	P218,5	H98,2
L300	P214	H98,2
L320	P214	H98,2
L326,6	P231,5	H98,2
L334,6	P218,5	H98,2

Vano rete / Inner spring support size / Compartimento somier / Logement sommier / Lattenrostaufnahme / Пром под сетку

90,5 x 200,5
120,5 x 200,5
140,5 x 200,5
152 x 200,5
155 x 205
160,5 x 200,5
180,5 x 200,5
187 x 218
195 x 205

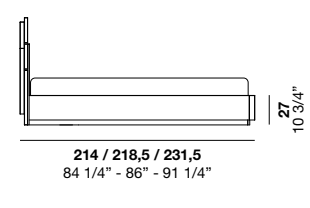
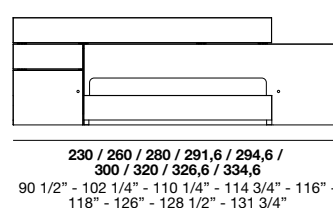
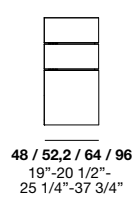



Suite System

SUITE SYSTEM

.....
letto / bed





Suite system letto /bed	L405 P208,9 H93,2
Fil moduli a sx /lsf units.....	L60 P48 H37,6
Fil moduli a dx /rsf units.....	L100 P48 H37,6
Fil composizione scrittoio/desk composition	L228 P59,9 H78,5
Denny pouf /pouf	L55 P55 H42







Suite system letto /bed	L360 P210 H113,2
Hobby comodino /night stand	L55,7 P44 H42
Hobby settimanale /4 drw chest	L79,8 P52,7 H99,8

Suite system

design CO³ Design Studio

Non solo un letto ma un vero sistema componibile che da ampia scelta di configurazioni e abbinamenti di finiture. Cinque le piattaforme disponibili in abbinamento ai pannelli imbottiti e alle boiserie dotate di pratiche mensole in metallo. Ampia la scelta di misure, anche con contenitore.

It is not just a bed, but a modular creation that allows for a wide range of configurations and combinations of finishes. There are five platforms available, which can be combined with the padded panels and wooden boiserie, fitted with functional metal shelves. It is available in a range of sizes, including with storage possibilities.

No solo una cama, sino un auténtico sistema componible que brinda amplias posibilidades de configuración y combinación de acabados. Hay cinco plataformas disponibles en combinación con los paneles tapizados y con las boiserías equipadas con cómodos estantes de metal. Disponible en una amplia selección de medidas, incluso con contenedor.

Non seulement un lit mais un vrai système modulable qui permet un ample choix de configurations et assortiments de finitions. Les encadrements disponibles en association aux panneaux rembourrés et aux boiseries équipées de pratiques étagères en métal sont cinq. Ample choix de dimensions, même avec coffre.

Mehr als nur ein Bett: ein kombinierbares Einrichtungssystem mit einer großen Auswahl bei der Kombination von Ausführungen. Es stehen fünf Liegeflächen zur Verfügung, die mit gepolsterten Platten und Wandverkleidungen mit praktischen Borden aus Metall kombiniert werden können. Große Auswahl bei Maßen, auch mit Bettkasten.

Ne только кровать, но настоящая сборная система, которая обеспечивает широкий выбор форм и сочетаний вариантов отделки. Предлагаются пять платформ в сочетании с панелями в мягкой обивке и буазери, оборудованные практичными металлическими полками. Широкий выбор размеров, а также вариант с контейнером.

Misure / Measurements / Medidas / Dimensions / Maße / Размеры

Vano rete / Inner spring support size / Compartimento somier / Logement sommier / Lattenrostaufnahme / Проем под сетку

P25
L165,5 P203 160,5 x 200,5

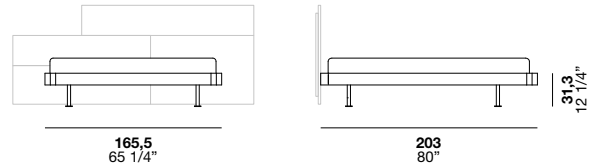

P18
L98,5 P204,5 90,5 x 200,5
L128,5 P204,5 120,5 x 200,5
L148,5 P204,5 140,5 x 200,5
L160 P204,5 152 x 200,5
L168,5 P204,5 155 x 205
L188,5 P204,5 160,5 x 200,5
L163 P209 180,5 x 200,5
L195 P222 187 x 218
L203 P209 195 x 205

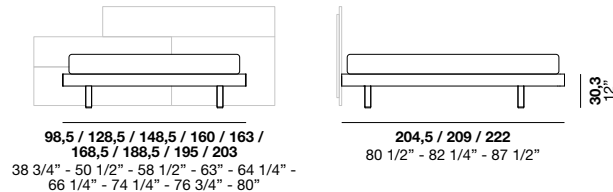

P24
L97,5 P204 90,5 x 200,5
L127,5 P204 120,5 x 200,5
L147,5 P204 140,5 x 200,5
L159 P204 152 x 200,5
L167,5 P204 155 x 205
L187,5 P204 160,5 x 200,5
L162 P208,5 180,5 x 200,5
L194 P221,5 187 x 218
L202 P208,5 195 x 205

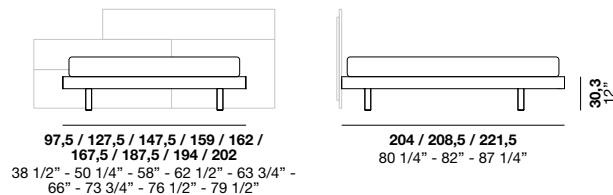

GL01
L102,5 P208 90,5 x 202
L132,5 P208 120,5 x 202
L152,5 P208 140,5 x 202
L164 P208 152 x 202
L172,5 P208 155 x 207
L192 P208 160,5 x 202
L167 P213 180,5 x 202
L199 P225 187 x 219
L207 P213 195 x 207

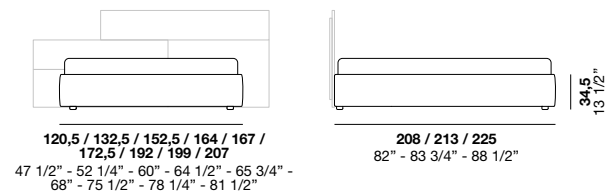

GL02
L104,5 P209 90,5 x 202
L134,5 P209 120,5 x 202
L154,5 P209 140,5 x 202
L166 P209 152 x 202
L174,5 P209 155 x 207
L194 P209 160,5 x 202
L169 P214 180,5 x 202
L201 P226 187 x 219
L209 P214 195 x 207

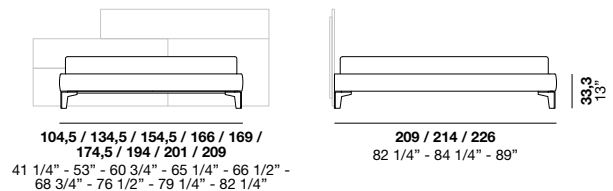

Disponibile anche con contenitore / Also available with storage unit / Disponible también con contenedor / Également disponible avec coffre / Erhältlich auch mit Bettkasten / Предусмотрен вариант с контейнером

Boiserie / Wooden panelling / Boiserie / Boiserie /
Wandverkleidung / Буазери

L 45 / 60 / 90 / 105 / 120 / 135 / 150 / 165 cm

17,8	27,8	35,6	17,8	45,6	17,8	53,4	17,8	55,6	17,8	27,8		
			17,8		27,8		17,8		35,6	27,8		
63,4	17,8	27,8	17,8	71,2	17,8	17,8	35,6	17,8	73,4	17,8	27,8	17,8
	17,8				17,8	17,8				27,8		
	27,8	35,6	45,6		17,8	35,6	35,6	53,4		27,8	45,6	55,6
					17,8					27,8		
81,2	17,8	17,8	17,8	35,6	27,8	17,8	83,4	27,8	27,8			
	17,8	27,8	17,8					27,8	27,8			
	17,8				53,4	63,4				55,6		
	27,8	35,6	45,6	45,6						27,8		
91,2	17,8	27,8	17,8	35,6	17,8	27,8						
	17,8											
	27,8	27,8	17,8									
	27,8	35,6	55,6	55,6	73,4	63,4						
101,2	17,8	27,8	17,8	45,6	27,8	17,8	111,2	27,8	27,8	55,6	27,8	
	27,8							27,8	27,8			
	27,8							27,8	55,6	55,6		83,4
	27,8	45,6	55,6	55,6	73,4	83,4		27,8	55,6	55,6		

Fil moduli a giorno / Fil open units
/ Fil módulos abiertos / Fil modules
ouverts / Fil offene Module
/ Открытые модули Fil

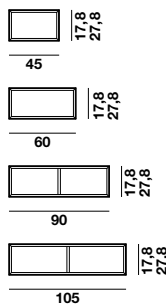

Mensole in metallo / Metal shelves
/ Estantes de metal / Étagères en
métal / Borde aus Metall
/ Металлические полки

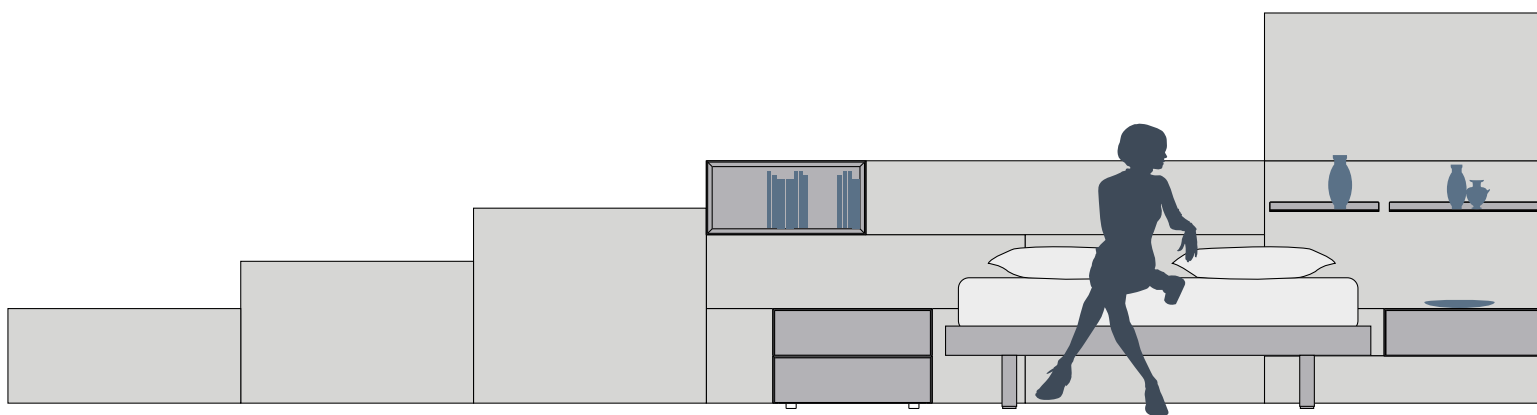
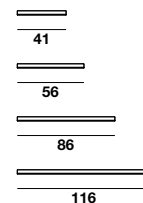



Teo

TEO

.....
letto / bed



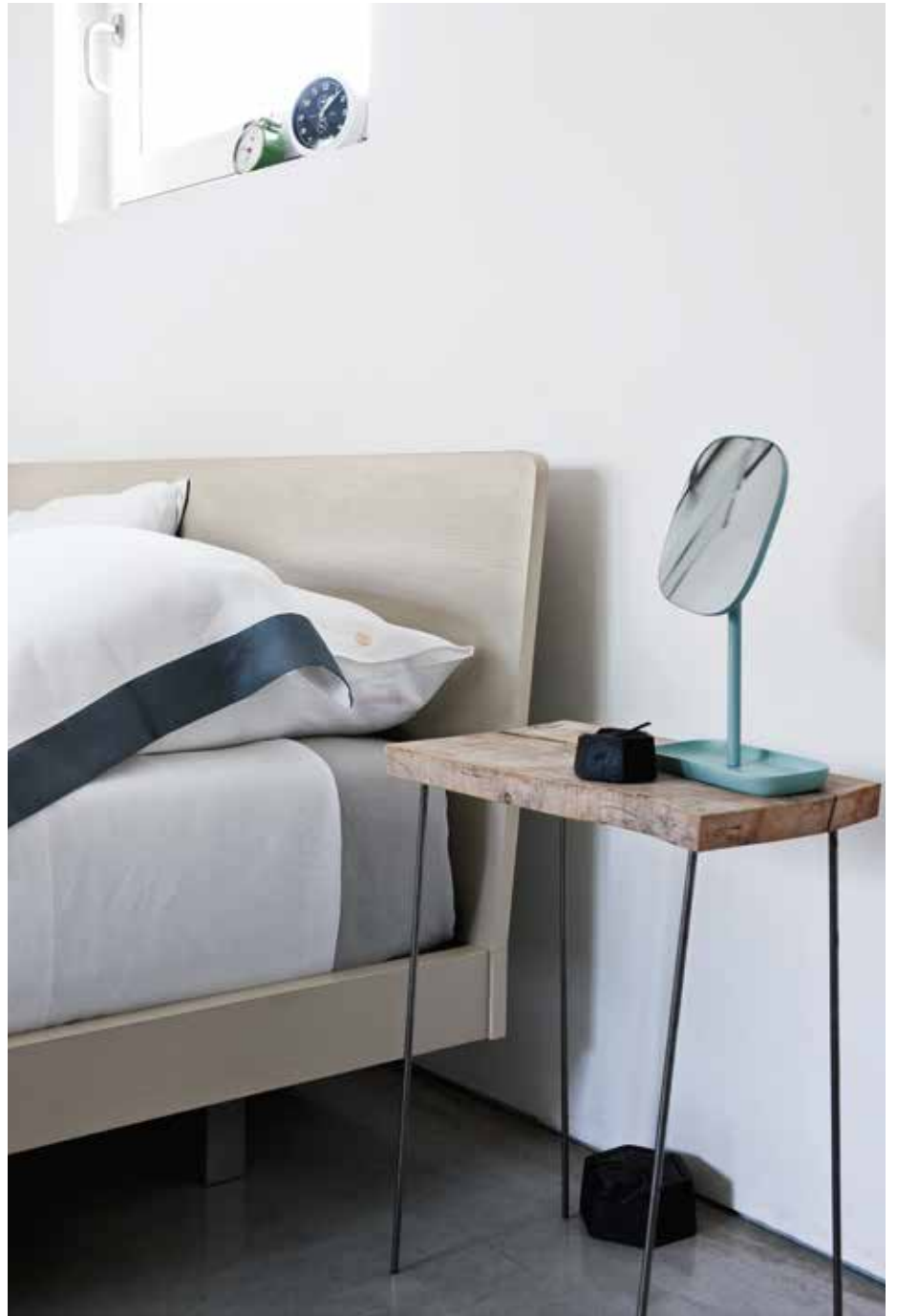

.....
Teo letto /bed **L169 P214 H91**
Ceppo tavolino /occasional table..... **L30 P30 H47**
.....





design **R.D.A. / Haften Studio**

Teo è un letto con struttura in legno dalle forme essenziali e moderne disponibile con tre varianti di piattaforma. Il pannello testiera può essere "vestito" da un cappuccio imbottito e trapuntato disponibile in tutti i rivestimenti a campionario. Dispone inoltre di una versione con contenitore.

Teo is a bed featuring a minimalist, modern wooden frame available with three different platform models. The headboard panel can be dressed with a padded, quilted hood, available in all sample box upholstery options. A version with a storage unit is also available.

Teo es una cama de madera de formas sencillas y modernas, disponible con tres variantes de plataforma. El panel de la cabecera puede "vestirse" con una funda tapizada y acolchada disponible en todos los revestimientos del muestrario. Hay también una versión con contenedor disponible.

Teo est un lit avec structure en bois aux formes essentielles et modernes disponible en trois versions d'encadrement. Le panneau de la tête de lit peut être "revêtu" d'une capuche rembourrée et matelassée disponible dans tous les revêtements du catalogue. Il dispose également d'une version avec coffre.

Teo ist ein Bett mit Holzkorpus mit schlichten und modernen Formen und einer Liegefläche, die in drei Varianten erhältlich ist. Die Kopfteilplatte kann mit einer Art gepolsterter Kapuze aus gestepptem Stoff verkleidet werden, die für alle Bezüge im Musterkatalog erhältlich ist. Das Bett ist zudem auch in einer Version mit Bettkasten erhältlich.

Teo - это кровать с деревянным каркасом строгих и современных форм, предлагаемая с тремя вариантами платформы. Панель головной спинки может быть "одета" в прошитый и стеганный капюшон из любой обивки, предлагаемой в наборе образцов. Предлагается также вариант с контейнером.

Misure / Measurements / Medidas / Dimensions / Maße / Размеры

Vano rete / Inner spring support size / Compartimento somier / Logement sommier / Lattenrostaufnahme / Проем под сетку

P18

L99	P214,5	H91	90,5 x 200,5
L129	P214,5	H91	120,5 x 200,5
L149	P214,5	H91	140,5 x 200,5
L160,5	P214,5	H91	152 x 200,5
L163,5	P219	H91	155 x 205
L169	P214,5	H91	160,5 x 200,5
L189	P214,5	H91	180,5 x 200,5
L195,5	P232	H91	187 x 218
L203,5	P219	H91	195 x 205

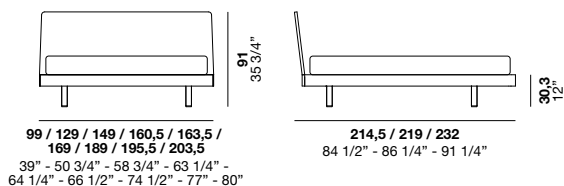

P24

L99	P214	H91	90,5 x 200,5
L129	P214	H91	120,5 x 200,5
L149	P214	H91	140,5 x 200,5
L160,5	P214	H91	152 x 200,5
L163,5	P218,5	H91	155 x 205
L169	P214	H91	160,5 x 200,5
L189	P214	H91	180,5 x 200,5
L195,5	P231,5	H91	187 x 218
L203,5	P218,5	H91	195 x 205

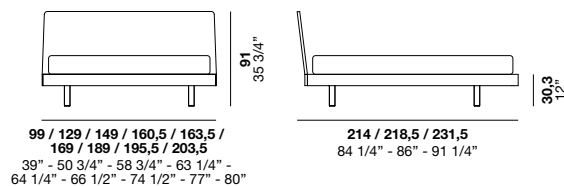

P22

L169	P214	H92	160,5 x 200,5
L189	P214	H92	180,5 x 200,5

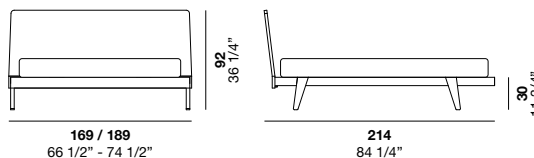

Disponibile anche con contenitore / Also available with storage unit / Disponible también con contenedor / Également disponible avec coffre / Erhältlich auch mit Bettkasten / Предусмотрен вариант с контейнером



Xilo

XILO

.....
letto / bed





Xilo letto /bedL174,5 P216 H95,2
Twice comò /dresser.....L120,3 P54 H74,2
Life tavolino /occasional tableL45 P55 H42





Xilo letto /bedL174,5 P216 H95,2
Da-do system comodino /night standL60 P45 H37,1





Xilo

design **Enrico Cesana**

Xilo è un letto con struttura in legno curvato e piedi in metallo. Si distingue per la stonatura ai lati della testiera e per le forme decise ma leggere della piattaforma. La possibilità della testiera rivestita in cuoio ne amplia le possibilità.

Xilo is a bed with a curved wooden structure and metal feet. It features rounded sides on the headboard and a bold but light platform. The headboard can also be upholstered in leather, making it even more adaptable.

Xilo es una cama con estructura de madera curvada y patas de metal. Se distingue por el perfil redondeado en los laterales de la cabecera y por las formas decididas pero ligeras de la plataforma. La opción de cabecera revestida de cuero amplía las posibilidades disponibles.

Xilo est un lit avec structure en bois arrondi et pieds en métal. Il se distingue pour les côtés arrondis de la tête de lit et pour les formes nettes mais légères de l'encadrement. La possibilité de la tête de lit revêtue en cuir en augmente les possibilités.

Xilo ist ein Bett mit einem Holzkorpus und Füßen aus Metall. Sein Kennzeichen sind die abgerundeten Seiten des Kopfteils und die strenge aber leichte Form der Liegefläche. Ein Kopfteil mit Lederbezug erweitert die Auswahl.

Xilo - это кровать с каркасом из гнутого дерева и на металлических ножках. Она отличается закругленностью по бокам головной спинки и четкими, но легкими формами платформы. Предложение головной спинки с кожаной обивкой расширяет возможности этой модели.

Misure / Measurements / Medidas / Dimensions / Maße / Размеры

Vano rete / Inner spring support size / Compartimento somier / Logement sommier / Lattenrostaufnahme / Пром под сетку

L174,5 P216 H95,2 160,5 x 200,5

Disponibile anche con contenitore / Also available with storage unit / Disponible también con contenedor / Également disponible avec coffre / Erhältlich auch mit Bettkasten / Предусмотрен вариант с контейнером

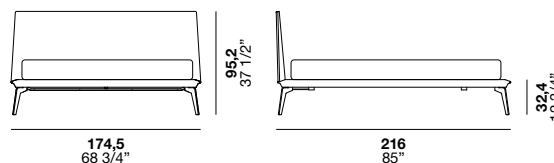

Xilo letto /bed..... L174,5 P216 H95,2
Timeless comodino /night stand L75 P45 H30,9
Shindo poltroncina /armchair..... L75 P80 H72
Timeless comò /dresser L145 P55 H70

Reti

/Bed springs
/Somieres
/Sommiers
/Lattenroste
/Сетки



Struttura ortopedica.

Orthopaedic spring structure.

Estructura ortopédica.

Structure orthopédique.

Orthopädischer Lattenrost.

Ортопедический каркас.



Rete ortopedica in appoggio.

Orthopaedic spring support.

Somier ortopédico apoyado.

Somier orthopédique à poser.

Aufgelegter orthopädischer Lattenrost.

Опорная ортопедическая сетка.



Rete ortopedica motorizzata.

Motorised orthopaedic spring support.

Somier ortopédico motorizado.

Somier orthopédique motorisé.

Motorisierter orthopädischer Lattenrost.

Моторизованная ортопедическая сетка.



Reti per contenitori

/Springs for storage units
/Somieres para contenedores
/Sommiers pour coffres
/Lattenroste für Bettkästen
/Сетки для контейнеров

/technical data

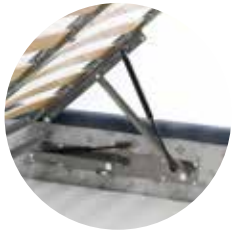

Letto imbottito con contenitore di tipo Comfort.



Padded bed with Comfort storage unit.

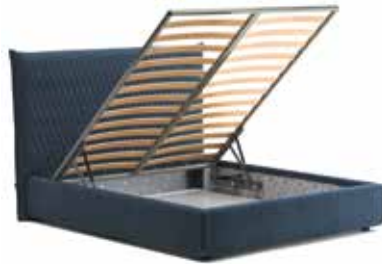

Cama tapizada con contenedor de tipo Comfort.



Polsterbett mit Bettkasten vom Typ Comfort.

Кровать с мягкой обивкой с контейнером Comfort.



Letto Teo con contenitore di tipo Basic.



Teo bed with Basic storage unit.

Cama Teo con contenedor de tipo Basic.

Lit Teo avec coffre de type Basic.

Bett Teo mit Bettkasten vom Typ Basic.

Кровать Teo с контейнером Basic.



Letto Xilo con contenitore di tipo Basic.



Xilo bed with Basic storage unit.

Cama Xilo con contenedor de tipo Basic.

Lit Xilo avec coffre de type Basic.

Bett Xilo mit Bettkasten vom Typ Basic.

Кровать Xilo с контейнером Basic.

Alf DaFrè STORAGE UNITS / BEDS

Materassi

/Mattresses
/Colchones
/Matelas
/Matratzen
/Матрасы

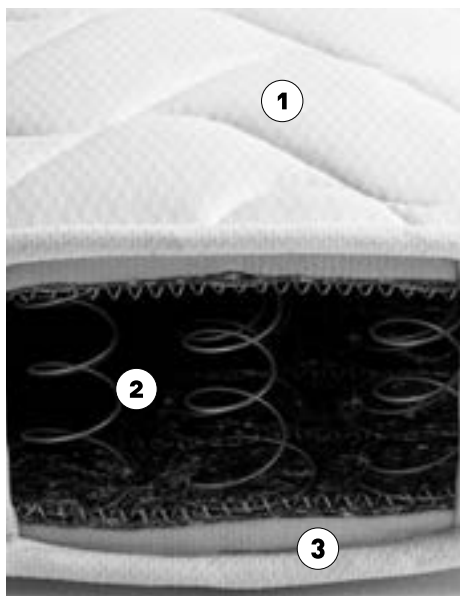

Alf Relax

- 1** Superficie di contatto in Elasfoam FC Fisiso Contact flessibile e traspirante massima traspirabilità.
FC Fisiso Contact Elasfoam top surface that is both flexible and breathable.
- 2** Molleggio box system con 390 molle tradizionali di tipo Bonnell sostegno bilanciato.
Box system springs with 390 traditional Bonnell coils for balanced support.
- 3** Imbottitura in fibre di lana, cotone e soffice tecnofibra Imbottitura a 5 strati con un cuore di aloe vera.
Wool-fibre, cotton and soft synthetic-fibre padding Five layers of padding with aloe vera at the core.



Alf Touch

- 1** Superficie di contatto in Elasfoam arricchita da Memory foam in trapuntatura.
Elasfoam top surface with Memory Foam in the quilting.
- 2** Struttura boxata con 700 molle insacchettate indipendenti differenziate in 7 zone.
Boxed structure with 700 individual pocketed springs divided into 7 areas.
- 3** Imbottitura traspirante a 3 strati, lana, lyocell e cotone.
Triple layered breathable padding: wool, lyocell and cotton.

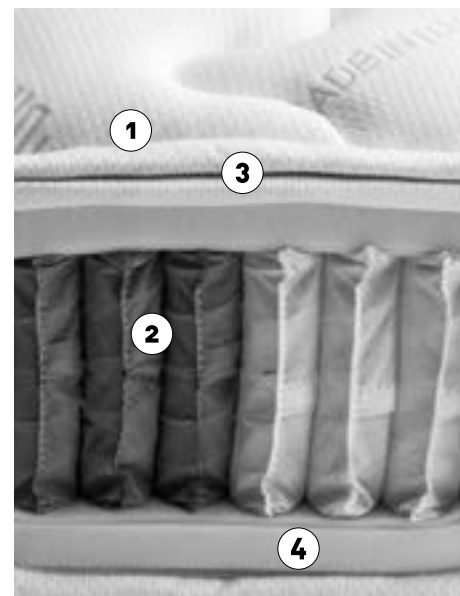

Alf Top

- 1** Superficie di contatto in Elasfoam con proprietà automodellanti.
Elasfoam top surface that adapts its shape.
- 2** Struttura boxata con 1700 molle insacchettate indipendenti differenziate in 7 zone.
Boxed structure with 1700 individual pocketed springs divided into 7 areas.
- 3** Pillow Top removibile aumenta l'accoglienza del materasso.
Removable Pillow Top, making the mattress even more inviting.
- 4** Imbottitura traspirante a 3 strati, lana, lyocell e cotone.
Triple layered breathable padding: wool, lyocell and cotton.



Alf Luck

- 1** Superficie di contatto in Memory foam regala una piacevole sensazione di accoglienza graduale.
Memory foam top surface for a pleasant, gradually enveloping feel.
- 2** Struttura in Elasfoam con 7 zone differenziate con inserto in Elasfoam ad alta densità assicura un supporto ottimale.
Elasfoam structure with 7 different areas and a thick Elasfoam insert for optimal support.
- 3** Imbottitura traspirante a 3 strati, lana, lyocell e cotone.
Triple layered breathable padding: wool, lyocell and cotton.

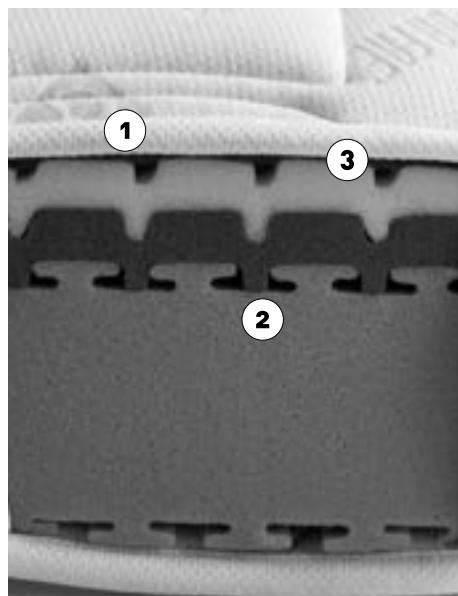

Alf Memory

- 1** Superficie di contatto in Fly-Dry, una speciale schiuma antibatterica e traspirante al 100%.
Top surface in Fly-Dry, an anti-bacterial, 100% breathable foam.
- 2** Struttura a 4 strati: Fly-Dry, 2 strati di Memory foam con proprietà automodellanti e 1 di flessibile e traspirante Elasfoam.
Quadri-layered structure: Fly-Dry, 2 layers of self-shaping Memory Foam and 1 layer of flexible, breathable Elasfoam.
- 3** Imbottitura traspirante a 3 strati, lana, lyocell e cotone.
Triple layered breathable padding: wool, lyocell and cotton.

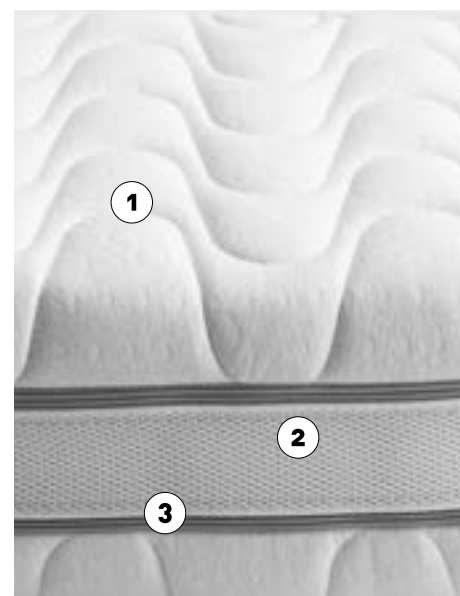

Alf Lattice

- 1** Struttura in schiuma di lattice a 7 zone differenziate, orono la giusta accoglienza dove serve.
Latex foam structure divided into 7 different areas to provide the right level of comfort, just where you need it.
- 2** La conformazione ad alveoli del lattice conferisce elasticità, termoregolazione e la giusta ventilazione al prodotto.
The cellular structure of the latex provides elasticity, heat control and the right flow of air through the product.
- 3** Tessuto in 100% cotone, fresco e sempre asciutto.
Fresh, dry 100% cotton fabric.
- 4** Imbottitura a 5 strati con un cuore di aloe vera.
Five layers of padding with aloe vera at the core.

art direction
Bruna Vaccher
Genny Canton

concept / set coordinator / graphic
Genny Canton Studio

photo
Contratti Company

digital image
Nudesign

styling
Claudia Barberi / Rosanna Bignucolo

separations
Luce srl

print
Sincromia

thanks to:
Carlo Vidoni Art Work
Poletto Pianta
Cordignano (Tv)
Arredamenti Bortoluzzi Due

ALF UNO Spa
Via S. Pio X 17
31018 Francenigo di Gaiarine
Treviso, Italy
Tel. +39 0438 997111
Fax Italia +39 0438 997245
Fax estero +39 0438 997246
www.alfdafre.it alf@alf.it

Verifica le finiture disponibili sul nostro sito internet. / Check the finishes available on our website. / Consulte los acabados disponibles en nuestro sitio web. / Vérifiez les finitions disponibles sur notre site internet. / Überprüfen Sie auf unserer Webseite, ob die gewünschte Ausführung erhältlich ist. / Познакомьтесь с вариантами отделки на нашем интернет-сайте www.alfdafre.it

ALF UNO s.p.a. si riserva di apportare in qualsiasi momento modifiche a prodotti, misure e materiali, che ritenesse utili per esigenze di carattere produttivo e commerciale. Per essere sempre aggiornati vi invitiamo a consultare il nostro sito internet www.alfdafre.it.

LE FINITURE

I materiali utilizzati dalla nostra azienda sono selezionati tra i più affidabili per applicazione e resa estetica. Nonostante questo devono considerarsi tollerabili alcune differenze dovute alle caratteristiche stesse di materiali come essenze naturali, vetri, laccature e all'artigianalità di alcune fasi del processo produttivo che da sempre è un nostro valore aggiunto. Inoltre alcune finiture possono subire nel tempo maturazioni dovute all'azione della luce e del tempo. È importante quindi specificare se nell'ordine vi sono sostituzioni o completamenti per valutare insieme il miglior modo di procedere. Le tonalità di colore e le finiture illustrate vanno considerate puramente indicative. Verificare sempre la fattibilità dell'abbinamento finiture consultando l'interno del listino.

ALF UNO s.p.a. reserves the right to make any changes to products, measurements and materials at any time deemed useful for manufacturing and sales purposes. To stay up to date at all times, please visit our website www.alfdafre.it

FINISHES

The materials we use are selected among the most reliable products in terms of application and aesthetic rendering. Despite this, certain differences due to the very characteristics of materials such as natural wood finishes, glass and lacquers must be considered tolerable, as well as the hand-crafted nature of certain phases of the production process, which has always been one of our added values. In addition, some finishes may change over time, due to the effects of light and time. It is therefore important to specify whether there are replacements or completions in the order to assess the best way to proceed together. The finishes featured in this sample collection are purely indicative and are not available for all products. Please check in the price list if the finish is available for the chosen item. Orders will not be accepted for products with finishes not included in the price list. The colour shades and finishes illustrated herein are to be considered purely indicative. Always check the feasibility of finish combinations by consulting the price list contents.

