

# Vestire lo spazio/

DRESSING UP YOUR SPACE

.....  
MIXER WARDROBE

**Alf DaFrè**



**Alf DaFrè**

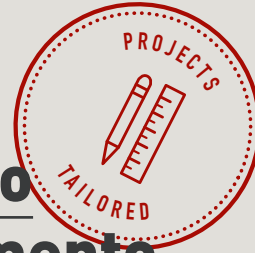

**L'armadio  
come un elemento  
d'architettura.  
Pareti che parlano  
il linguaggio  
della materia.  
Finiture affascinanti  
e dettagli ricercati.  
Volumi che si  
inseriscono  
in diversi spazi  
della casa.**

design **ENRICO CESANA**

The wardrobe as a piece of architecture.  
Walls that speak the language of different materials.  
Captivating finishes and elegant details.  
Shapes that fit into different spaces in the home.

El armario como elemento de arquitectura.  
Paredes que hablan el lenguaje de la materia.  
Acabados fascinantes y detalles elegantes.  
Volumenes que se integran en diversos espacios del hogar.

L'armoire comme un élément d'architecture.  
Des parois qui parlent le langage de la matière.  
Finitions pleines de charme et détails recherchés.  
Des volumes qui s'insèrent dans différents espaces de la maison.

Der Schrank als Element der Architektur.  
Eine Wand, die über Materie mit dem Raum kommuniziert.  
Faszinierende Oberflächen und elegante Details.  
Volumen, die sich in die Räume eines Zuhauses einfügen.

Шкаф как архитектурный элемент.  
Стенки, говорящие языком материи.  
Изумительная отделка и изысканные детали.  
Объемы, заполняющие различные пространства дома.

# Lo stile in una stanza

Style incarnate in your living space





# Index

## BATTENTI

Swinging

**pag. 008**   **Simple**

**pag. 014**   **Sliver**

**pag. 020**   **Strip**

## BATTENTI / SCORREVOLI

Swinging / Sliding

**pag. 026**   **Display**

**pag. 032**   **Rain**

**pag. 038**   **Simple**

**pag. 050**   **Split**

**pag. 056**   **Strip**

## **SCORREVOLI**

**Sliding**

- pag. 062 Vision**
- pag. 066 Frame**
- pag. 092 Quadra**
- pag. 106 Simple**
- pag. 112 Rubic**

## **COMPLANARI**

**Coplanar**

- pag. 124 Glide**



**Simple** p. 12



**Sliver** p. 18



**Sliver** p. 14



**Strip** p. 20



**Simple** p. 08

# **BATTENTI**

**Swinging**

**Simple  
Sliver  
Strip**

Simple/  
Un progetto  
di ampie  
prospettive

A project with a broad  
outlook

Un proyecto de amplias  
perspectivas

Un projet aux amples  
perspectives

Ein Projekt mit einem  
weitem Blick für den Raum

Проект с обширными  
перспективами





SIMPLE

MIXER

Alf DaFrè

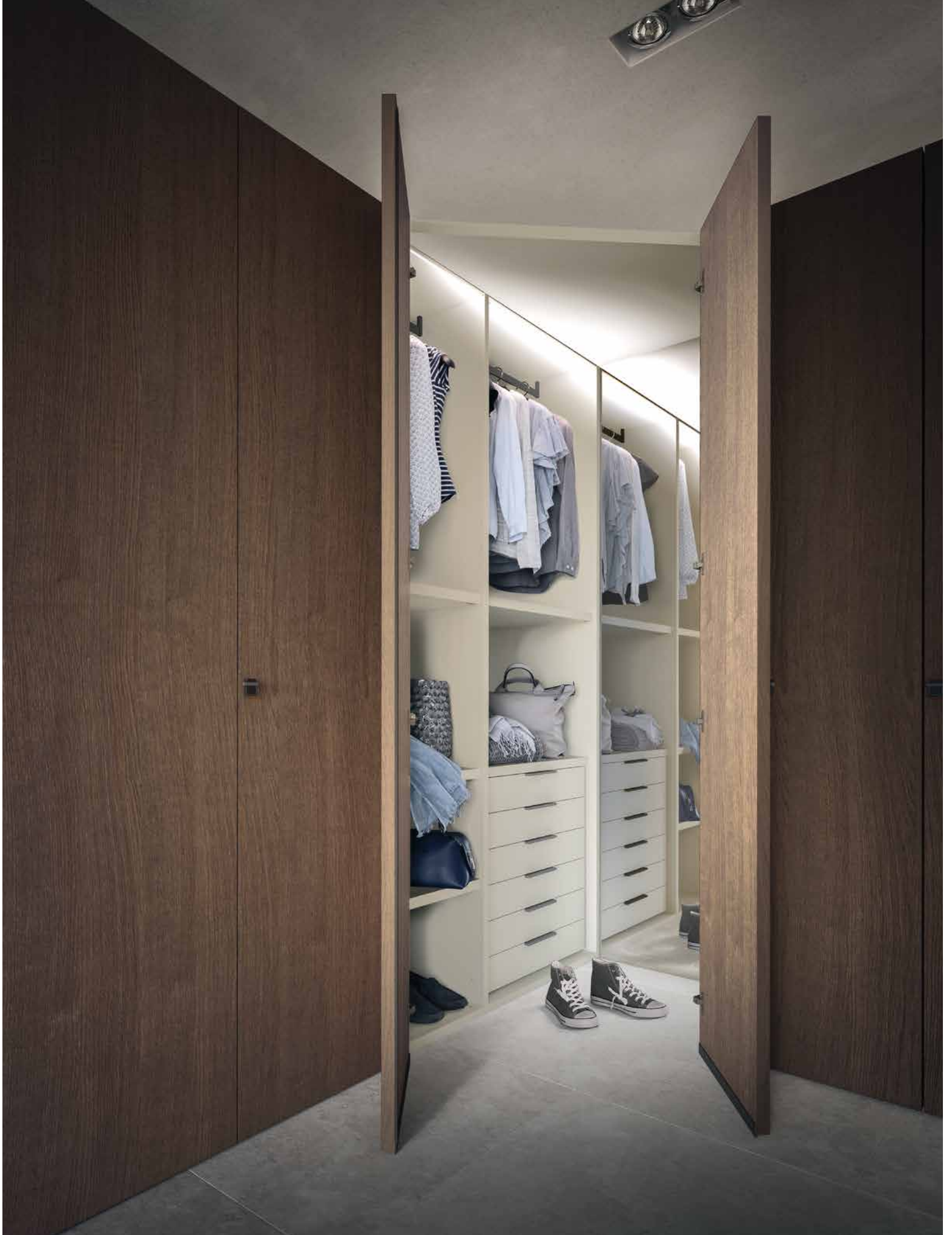



.....  
**Simple** battente /swinging ..... L624,4 x 472,9 P62,4 H255,1

Fashion wood Rovere Biscotto, maniglia Pomolo pelle /  
 Fashion Wood Biscotto oak, Pomolo leather handle

**Ladigue** divano /sofa ..... L314 P104 H74

**Jet set** poltrona /armchair ..... L77 P87 H80

**Normann** tavolino /occasional table ..... L70 P120 H33,6



# Simple/ Una maniglia caratterizzante

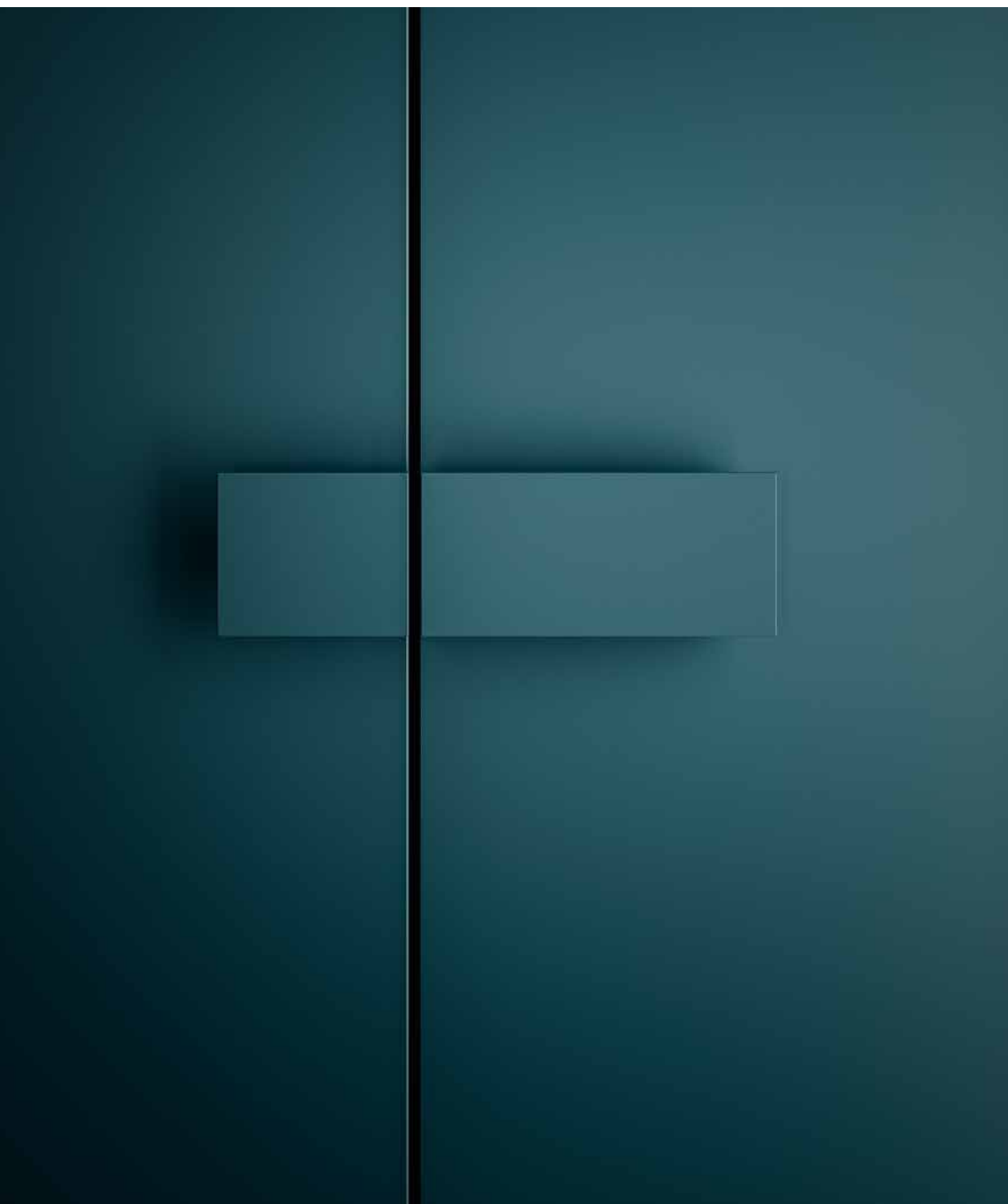

..... **Simple** battente /swinging ..... **L341,8 P62,4 H255,1**

Laccato opaco Blu notte, maniglia Elios /  
Matt Blu Notte lacquer, Elios handle





A feature handle

Un tirador con personalidad

Une poignée caractérisante

Ein Griff mit Charakter

Характерная ручка



# Sliver/ Chiaro e lineare

Clear and linear  
Claro y lineal  
Clair et linéaire  
Klar und linear  
Светлый и линейный

- Sliver** battente /swinging ..... L352,2 P61,6 H255,1  
Laccato opaco Conchiglia / Matt Conchiglia lacquer
- Wok box** tavolino /occasional table ..... Ø35 H43
- Life** tavolino /occasional table ..... L55 P45 H42









**Sliver/**  
**Il dettaglio**  
**che fa**  
**presa**

.....  
**Sliver** battente /swinging ..... L456 x 451 P61,6 H255,1

Laccato opaco Arena / Matt Arena lacquer

**Ceppo** tavolino /occasional table ..... Ø30 H47





Details that get noticed

El detalle que llega hondo

Le détail qui fait effet

Ein griffiges Detail

Деталь с функцией захвата







**Strip/  
Architetture  
verticali  
e di forte  
presenza.**





Bold, vertical architecture.

Arquitecturas verticales y de gran presencia.

Architectures verticales et à la présence forte

Vertikale Linien und eine starke Persönlichkeit

Вертикальная и впечатляющая архитектура



**Strip** battente /swinging ..... L454,9 P62,4 H255,1

Fashion wood Rovere Terra, Laccato lucido Fango /  
Fashion Wood Terra oak, glossy Fango lacquer

**Tuft** tavolino /occasional table ..... Ø60,3 H36,8

**Life** tavolino /occasional table ..... Ø46 H52





STRIP

MIXER

Alf DaFrè





**Rain** p. 32



**Display** p. 26



**Split** p. 50



Simple p. 44



Simple p. 38



Strip p. 56

## **BATTENTI / SCORREVOLI**

**Swinging / Sliding**

**Display  
Rain  
Simple  
Split  
Strip**

**Display/**  
**Il guardaroba**  
**diventa una**  
**boutique**



The wardrobe-come-boutique

El ropero se convierte en una boutique

La garde-robe devient une boutique

Aus der Garderobe wird eine Boutique

Шкаф-купе становится бутиком













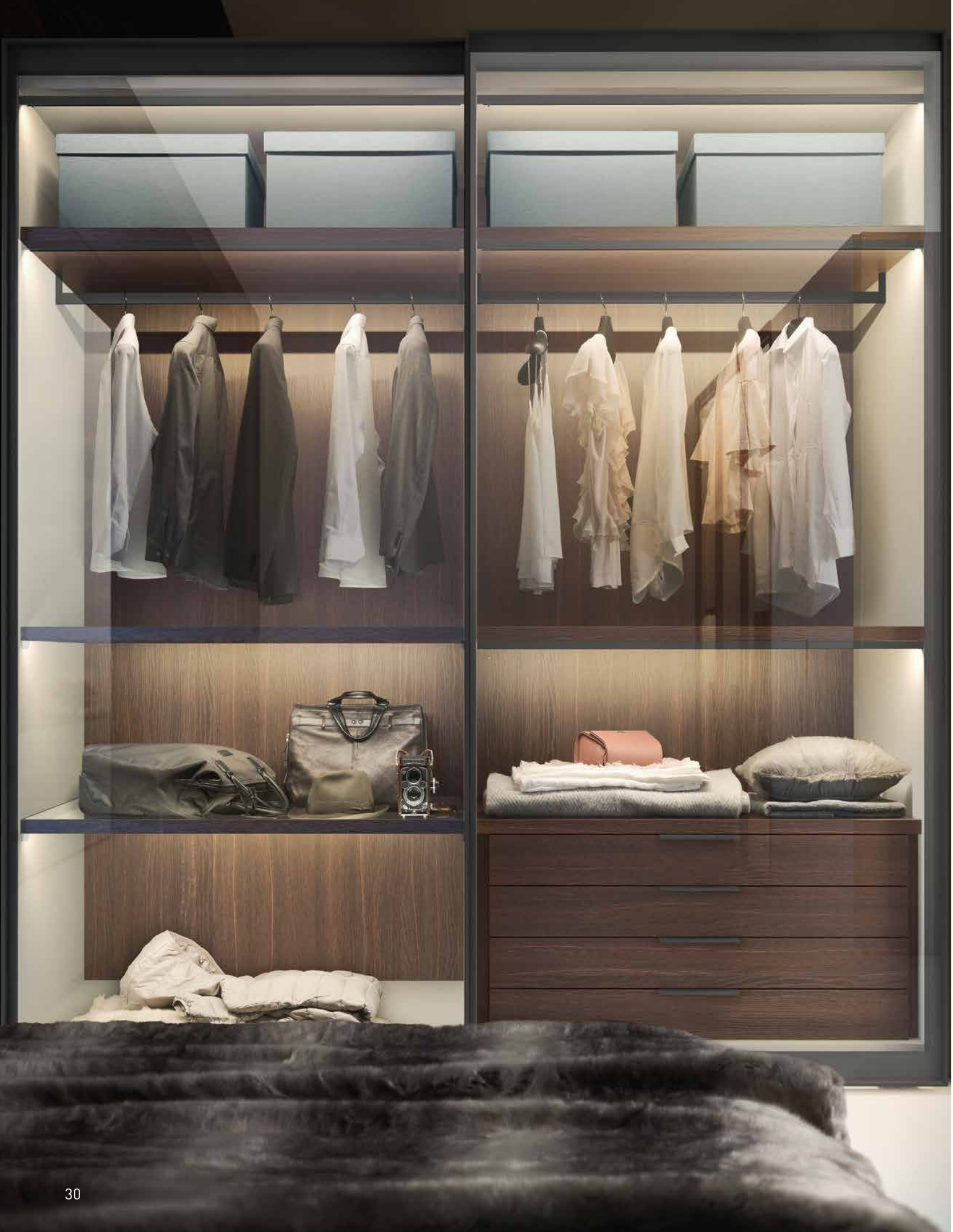



.....  
**Display** scorrevole /sliding ..... L681,1 P69 H255,1

Telaio Moka shine, Vetro Trasparente grigio /  
 Moka Shine frame, Grigio transparent glass

**Display/Sliver** battente /swinging ..... L341,8 P62,6 H255,1

Laccato opaco Conchiglia, Telaio Moka shine, Vetro Trasparente grigio /  
 Matt Conchiglia lacquer, Moka Shine frame, Grigio transparent glass

**Xilo** letto /bed ..... L174,5 P216 H95,2

**Rain/  
Le pareti  
diventano  
protagoniste**





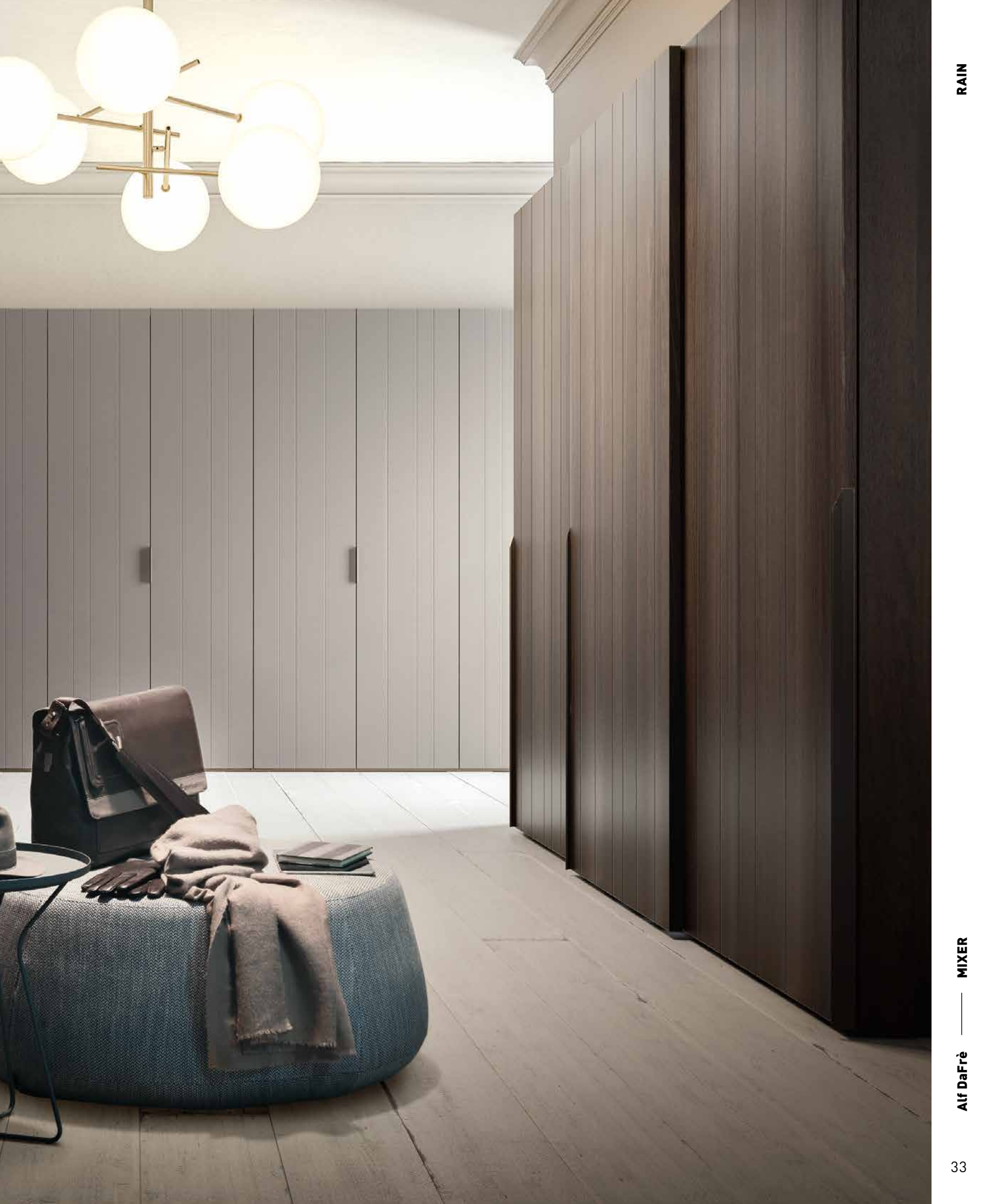



The walls become the star  
of the show

Las paredes se hacen  
protagonistas

Les parois deviennent  
protagonistes

Hier spielen die Wände die  
Hauptrolle

Стенки становятся  
основными элементами







**Rain** battente /swinging ..... L568 P62,4 H255,1

Laccato opaco Piombo, Maniglia Timeless Moka shine /  
Matt Piombo lacquer, Timeless Moka Shine handle

**Rain** scorrevole /sliding ..... L341,8 P67 H255,1

Fashion wood Rovere Terra, Maniglia 3D Moka shine /  
Fashion Wood Terra oak, 3D Moka Shine handle

**Denny** pouf /footstool ..... Ø55/85 H42/37

**Tuft** tavolino /occasional table ..... Ø40,3 H46,3

**Oregon** letto /bed ..... L187 P225 H102

**Twice** comodino /night stand ..... L64 P47,4 H44,4

**Twice** settimanale /5 drw chest ..... L64 P47,4 H123,8

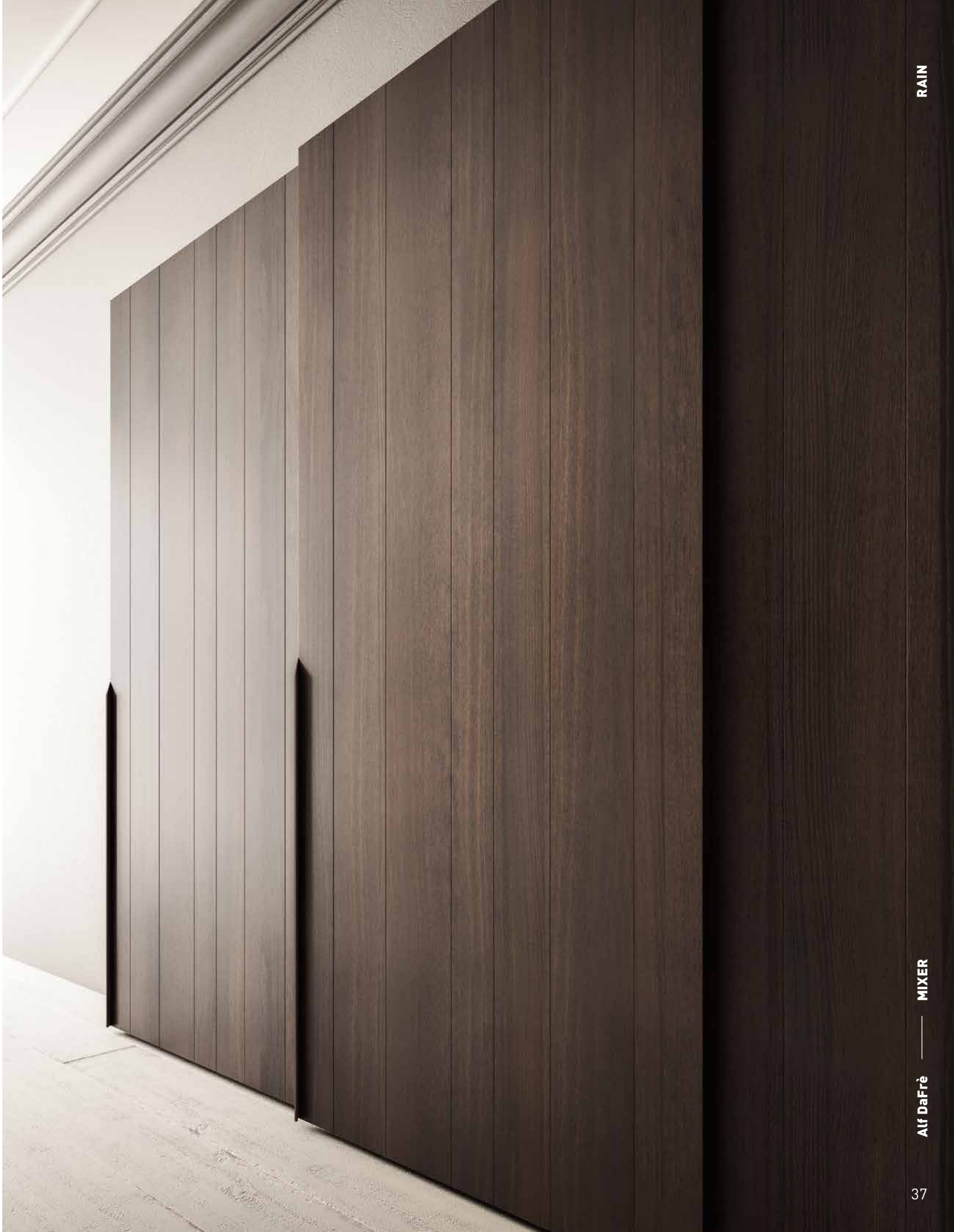



**Simple/  
Armadio  
angolare  
con scrittoio  
integrato.**









Corner wardrobe with  
built-in desk.

Armario rinconero con  
escritorio integrado.

Armoire d'angle avec  
bureau intégré.

Eckschrank integrierter  
mit Schreibtischplatte.

Угловой шкаф с  
встроенным письменным  
столом.







.....  
**Simple battente /swinging** ..... L495,4 P62,4 H255,1

Laccato opaco Arena, Maniglia 3D Moka shine /  
 Matt Arena lacquer, 3D Moka Shine handle

**Simple scorrevole /sliding** ..... L341,8 P67 H255,1

Laccato opaco Arena, Maniglia 3D Moka shine /  
 Matt Arena lacquer, 3D Moka Shine handle

**Viky sedia /chair** ..... L59 P52 H76,5



SIMPLE

Alf DaFrè — MIXER







**Simple/  
Due tipologie,  
una personalità.**



Two models,  
one personality.

Dos tipos, una  
personalidad.

Deux typologies, une  
personnalité.

Die zwei Seiten einer  
Persönlichkeit.

Два варианта, один  
характер.



**Simple battente /swinging** ..... **L568 P62,4 H255,1**

Fashion wood Rovere Terra, Maniglia C16 Moka shine /  
Fashion Wood Terra oak, C16 Moka Shine handle

**Simple scorrevole /sliding** ..... **L341,8 P67 H255,1**

Laccato opaco Sabbia, Maniglia C16 Moka shine /  
Matt Sabbia lacquer, C16 Moka Shine handle











**Split/**  
**Ambiente**  
**giorno con**  
**guardaroba**  
**e zona TV**















Living space with wardrobe  
and entertainment area

Ambiente de dia con ropero  
y zona TV

Espace jour avec garde-  
robe et zone TV

Wohnbereich mit  
Garderobe und TV-Zone

Гостиная с шкафом-купе и  
ТВ-зоной







SPLIT



**Split battente /swinging** ..... L454,9 P62,4 H255,1

Fashion wood Rovere Carbone, Profilo Moka Shine /  
Fashion Wood Carbone oak, Moka Shine handle profile

**Split scorrevole /sliding** ..... L454,9 P67 H255,1

Laccato opaco Platino /  
Matt Platino lacquer

**Denny pouf /footstool** ..... Ø55/85 H42/37

**Life tavolino /occasional table** ..... L55 P45 H42

MIXER

Alf DaFrè

**Strip/**  
**Un dialogo**  
**di forme,**  
**colori e**  
**superfici**

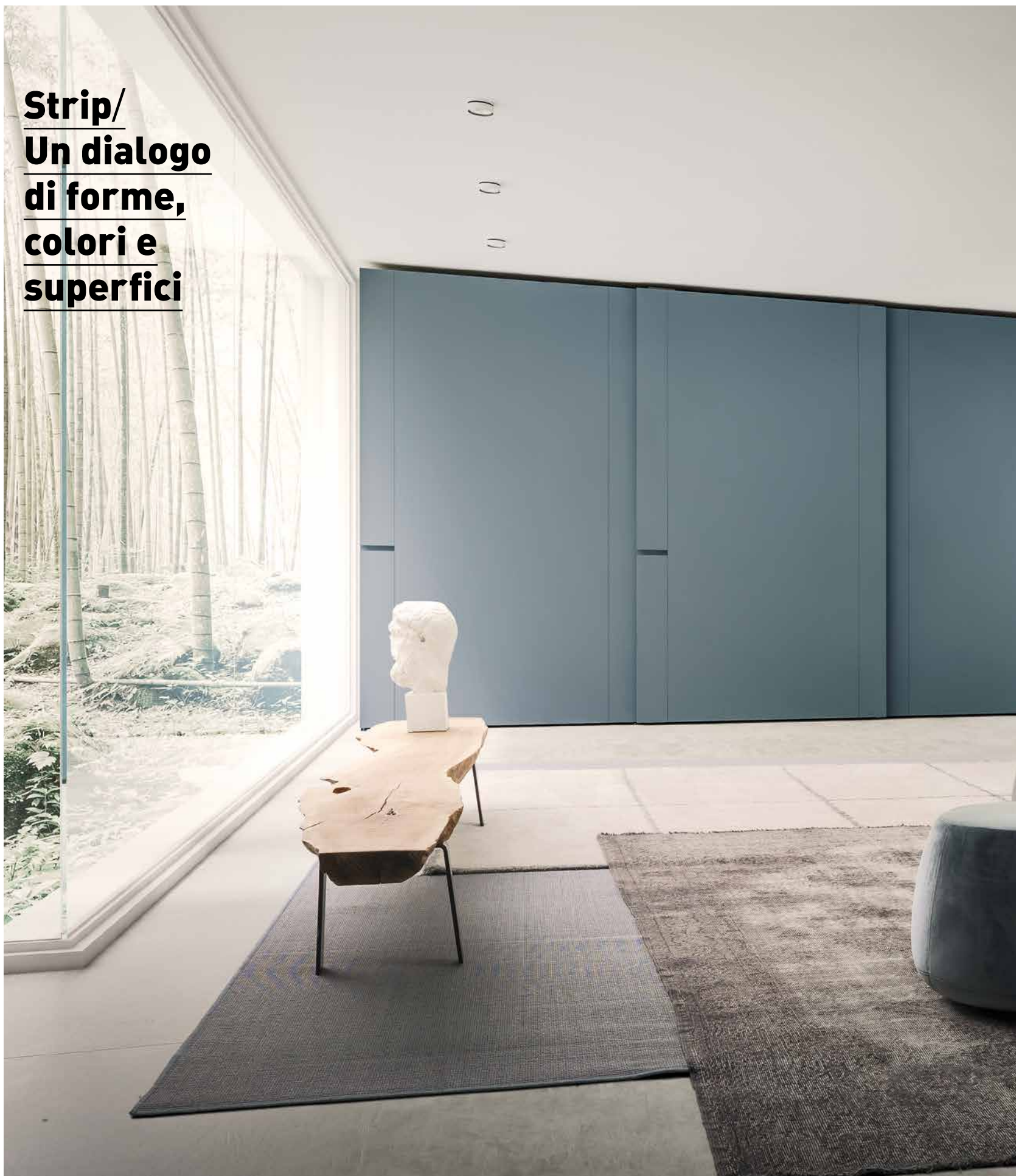





A dialogue between  
different shapes, colours  
and surfaces

Un diálogo de formas,  
colores y superficies

Un dialogue de formes,  
coloris et surfaces

Formen, Farben und  
Oberflächen in einem  
spannenden Dialog

Диалог форм, цветов и  
поверхностей





STRIP

.....  
**Strip** battente /swinging ..... L454,9 P62,4 H255,1

Laccato opaco Tortora, Rovere laccato opaco Tortora /  
Matt Tortora lacquer, matt Tortora lacquered oak

**Strip** scorrevole /sliding ..... L442,2 P67 H255,1

Laccato opaco Pacifico /  
Matt Pacifico lacquer

**Denny** pouf /footstool ..... Ø55/85/130 H42/32/37

**Wok** tavolino /occasional table ..... Ø27,5 H50

MIXER

Alf DaFrè





**Frame** p. 88



**Frame** p. 78



**Frame** p. 74



**Rubic** p. 114



**Frame** p. 90



**Quadra** p. 97



**Quadra** p. 100



**Frame** p. 82



**Frame** p. 66



**Vision** p. 62



**Quadra** p. 92



**Simple** p. 106



**Vision** p. 70

# **SCORREVOLI**

**Sliding**

- Vision**
- Frame**
- Quadra**
- Simple**
- Rubic**



Midway between a living  
and bedroom space

Entre el día y la noche

Entre le jour et la nuit

Zwischen Tag und Nacht

Между днем и ночью



Vision/  
Tra il  
giorno  
e la  
notte

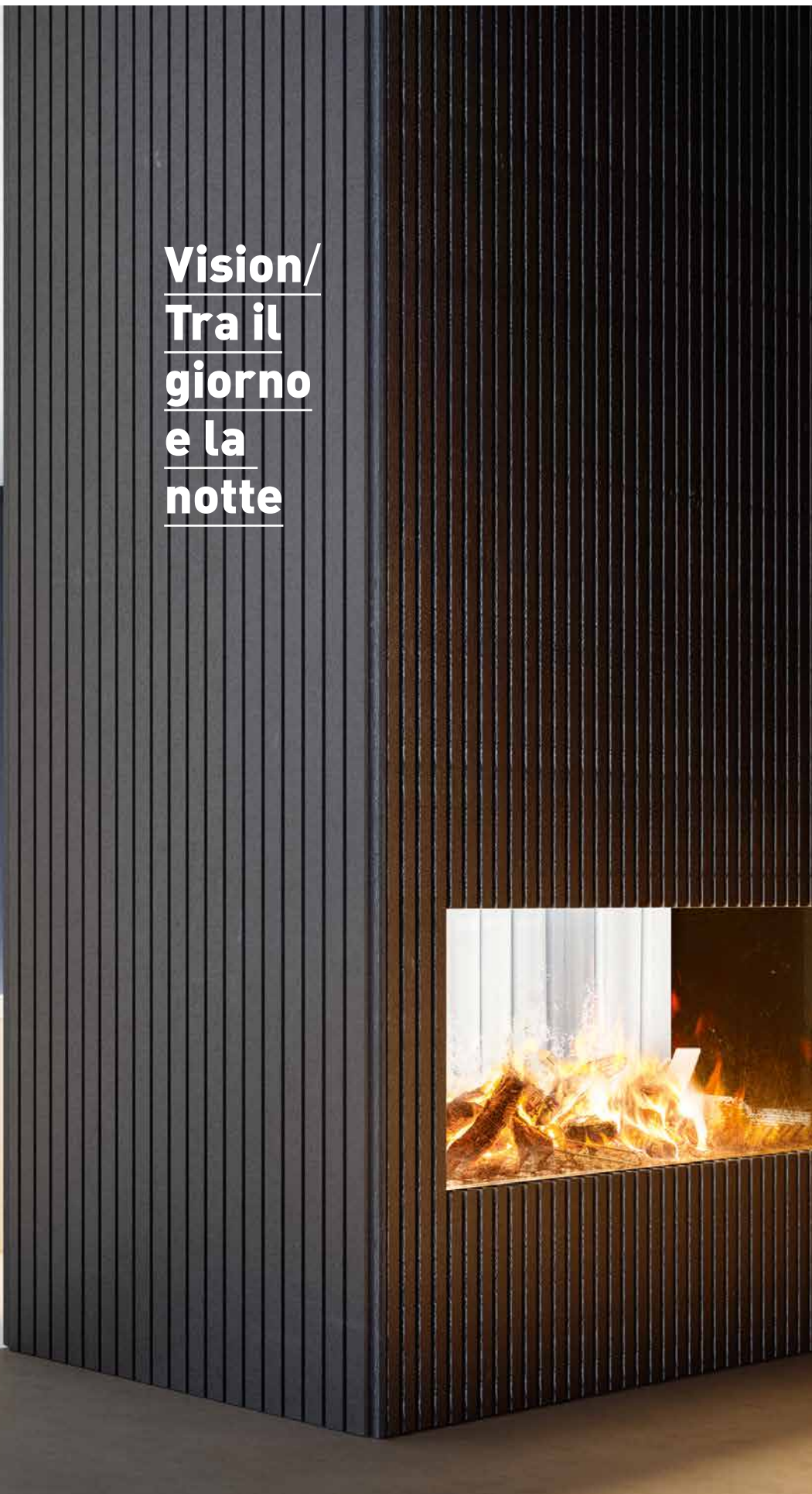



.....  
**Vision** scorrevole /sliding ..... L454,9 P67 H255,1 **ASOLO**\_first floor

Specchio, Laccato opaco Tè verde, Profilo Laccato opaco Tè verde /  
Mirror, matt Tè Verde lacquer, matt Tè Verde lacquered profile

**Tuft** tavolino /occasional table ..... Ø40,3 H46,3

---





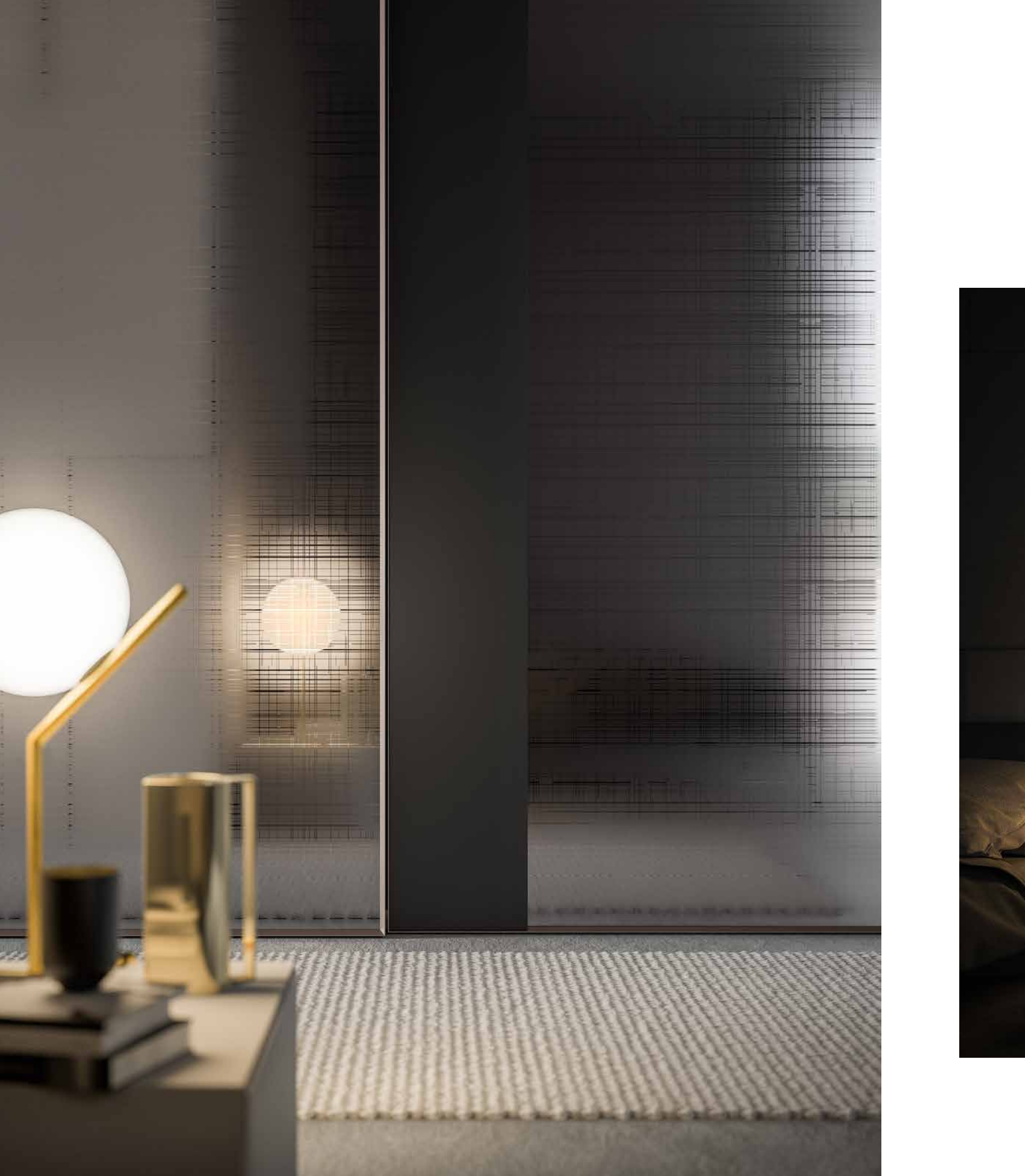

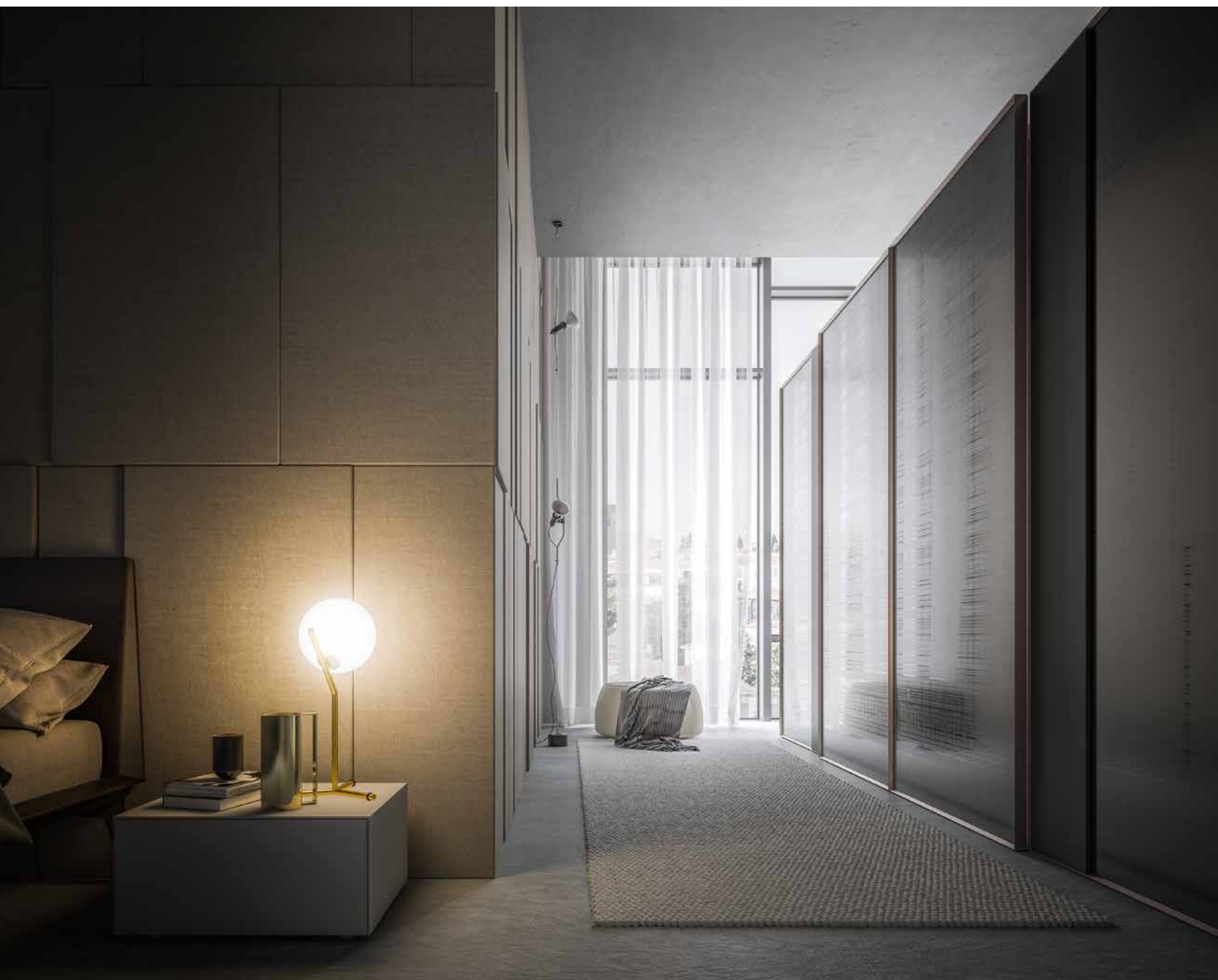

**Frame scorrevole /sliding** ..... **L393,3 P69 H255,1**

Vetro serigrafato Grigio lino, Laccato Modica opaco, Profilo Moka shine /  
Grigio Lino silk-screened glass, matt Modica lacquer, Moka Shine profile

**Frame/  
Piani  
e finiture  
sovrapposte**







Overlapping surfaces and finishes

Superficies y acabados superpuestos

Plans et finitions superposées

Ein Spiel mit Ebenen und Flächen

Игра поверхностей и отделки

**Vision/  
Risolve  
qualsiasi  
spazio**



Define any space

Una solución para  
cualquier espacio

Une solution à tout espace

Eine Lösung für jeden  
Raum

Для любого пространства







Full-length handle.

Tirador de altura completa.

Poignée sur toute la hauteur.

Ein durchgehender Griff.

Ручка по всей высоте.

## Vision/ Maniglia a tutta altezza

|  |                    |
|--|--------------------|
| <b>Vision</b> scorrevole /sliding .....  | L341,8 P67 H255,1  |
| Vetro lucido Modica, Profilo Moka shine /<br>Glossy Modica glass, Moka Shine profile |                    |
| <b>Allen</b> letto /bed .....  | L186 P215 H129     |
| <b>Hobby</b> comodino /night stand .....   | L41,7 P44 H42      |
| <b>Hobby</b> comò /dresser .....   | L134,2 P52,7 H75,4 |

**Frame/  
Piani  
e finiture  
sovrapposte**







Overlapping surfaces and finishes

Superficies y acabados superpuestos

Plans et finitions superposées

Ein Spiel mit Ebenen und Flächen

Игра поверхностей и отделки





.....  
**Frame** scorrevole /sliding ..... L341,8 P69 H255,1

Vetro acidato Platino, Fashion wood Rovere Fossile, profilo Moka shine /  
Platino etched glass, Fashion Wood Fossile oak, Moka Shine profile

**Xilo** letto /bed ..... L174,5 P216 H95,2

**Timeless** comodino /night stand ..... L60 P45 H43,7

---

---





A functional aesthetic  
frame

Un marco estético y  
funcional

Un cadre esthétique et  
fonctionnel

Ein ästhetischer und  
funktionaler Rahmen

Эстетичная и  
функциональная рамка

**Frame/  
Una  
cornice  
estetica e  
funzionale**









.....  
**Frame** scorrevole /sliding ..... L454,9 P69 H255,1

Specchio Grigio, Laccato opaco Calce, Profilo laccato opaco Calce /  
 Grigio mirror, matt Calce lacquer, matt Calce lacquered profile

**Da-do system** comò /dresser ..... L133 P53 H74,4

**Frame/  
Suddividere  
e organizzare  
la casa**







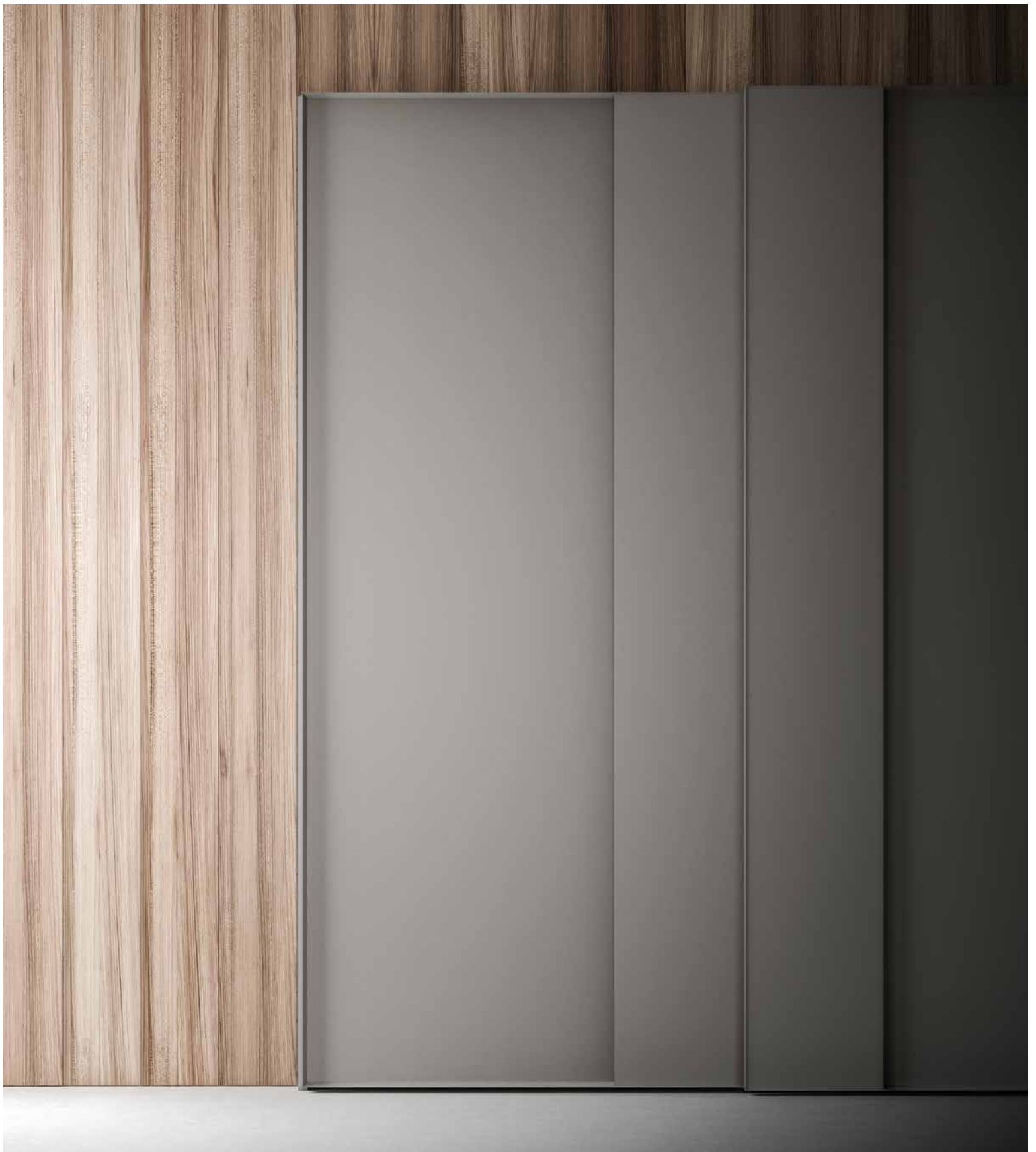

Divide and organise your home

Dividir y organizar el hogar

Diviser et organiser la maison

Einteilung und Organisation für Ihr Zuhause

Подразделить и организовать дом

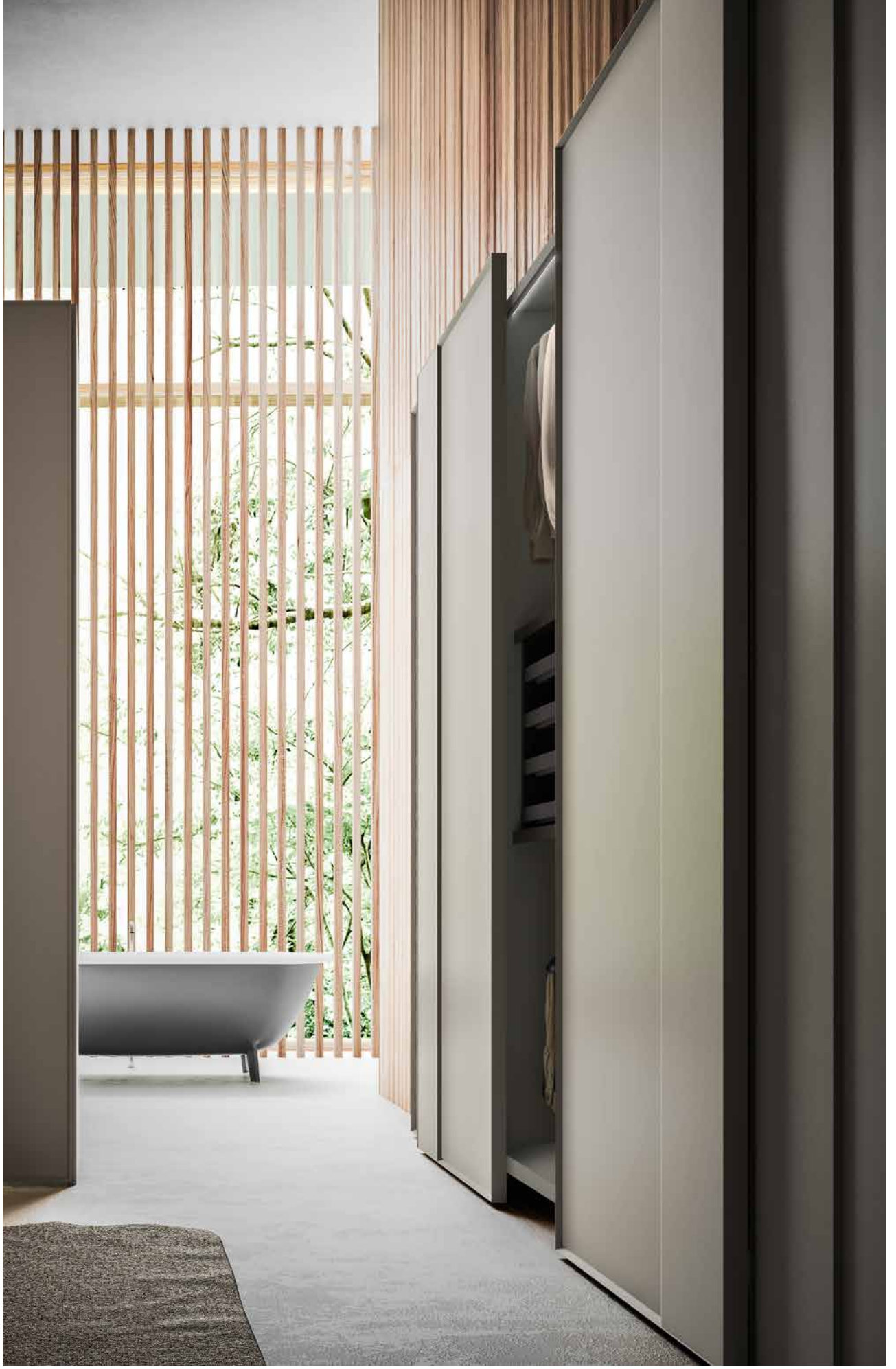







.....  
**Frame** scorrevole /sliding ..... **L454,9 P69 H255,1**

Laccato opaco Platino /  
 Matt Platino lacquer

**California** letto /bed ..... **L177 P230 H75**

**Fil** moduli a sx /lsf units ..... **L120 P48 H35,6**

**Fil** moduli a dx /rsf units ..... **L135 P48 H57,6**

---







**Frame** scorrevole /sliding

Vetro serigrafato Sari, Laccato opaco Platino, Profilo opaco Laccato Platino /  
Sari silk-screened glass, matt Platino lacquer, matt Platino-lacquered profile

**Olivia** poltroncina /armchair

**Tuft** tavolini /occasional tables

L341,8 P69 H255,1

L106 P93 H89

Ø40,3 H46,3

Ø60,3 H36,8





**Frame scorrevole /sliding** ..... **L341,8 P69 H255,1**

Vetro serigrafato Asà, Laccato opaco Platino, Profilo Laccato opaco Platino /  
Asà silk-screened glass, matt Platino lacquer, matt Platino lacquered profile

**Morrison letto /bed** ..... **L197 P229 H92**





Quadra/  
Riflessi  
di luce e  
venature  
naturali







Light reflections and  
natural grain

Reflejos de luz y vetas  
naturales

Reflets de lumière et  
veinures naturelles

Lichtreflexe und natürliche  
Maserungen

Отражение света и  
натуральная текстура







**Quadra** scorrevole /sliding ..... L341,8 P67 H255,1

Specchio Grigio, Fashion wood Rovere Carbone /  
Grigio mirror, Fashion Wood Carbone oak

**Morrison** letto /bed ..... L197 P229 H92



**Quadra/**  
**La valenza**  
**architettonica**  
**dell'armadio**

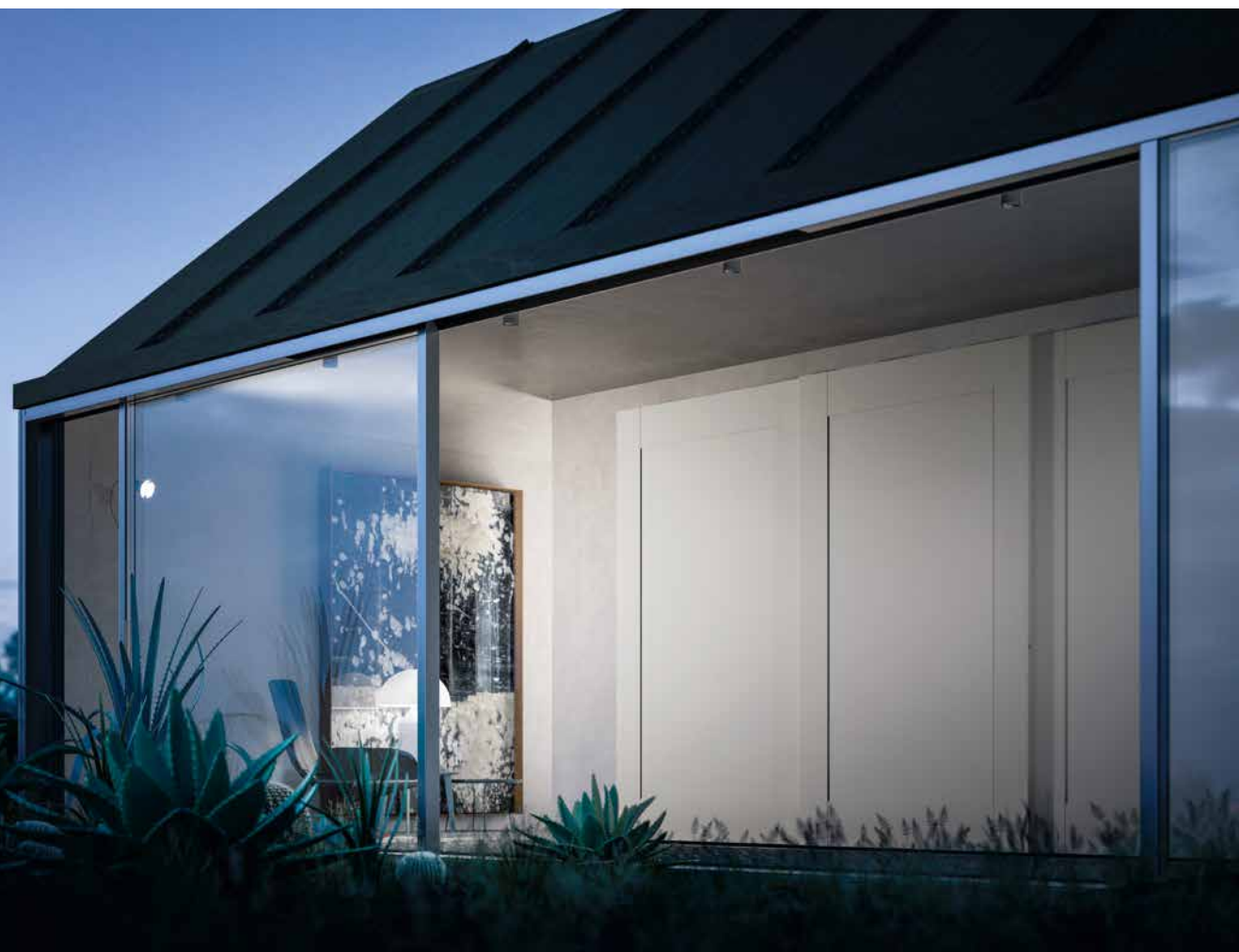



The wardrobe with architectural impact

El valor arquitectónico del armario

La valeur architecturale de l'armoire

Der Schrank als Architektur

Архитектурная сущность шкафа



---

**Quadra** scorrevole /sliding ..... L442,2 P67 H255,1

Laccato opaco Platino, Maniglia Inner /  
Matt Platino lacquer, Inner handle

**Tuft** tavolino /occasional table ..... Ø60,3 H36,8

**Life** tavolino /occasional table ..... L55 P45 H42

---





**Quadra/  
Materiali  
e dettagli  
artigianali**







Artisan materials and details

Materiales y detalles artesanales

Matériaux et détails artisanaux

Handwerklich verarbeitetes Material mit besonderen Details

Материалы и детали мастерской обработки



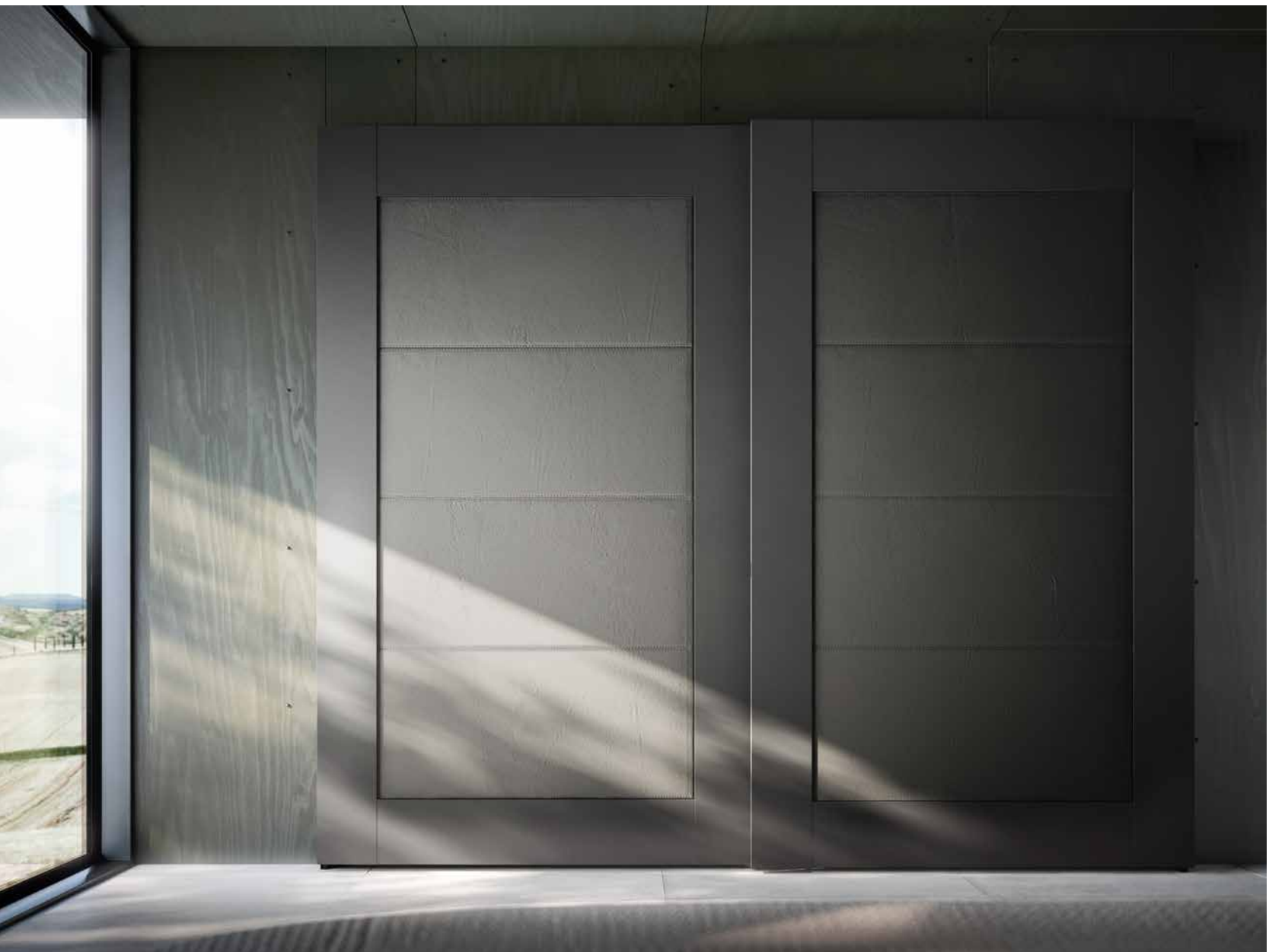

.....  
**Quadra** scorrevole /sliding ..... **L295,6 P67 H255,1**

Laccato opaco Modica, Pelle Lord 9190 /  
Matt Modica lacquer, Lord 9190 leather

**Da-do system** comodino /night stand ..... **L90 P53 H37,1**

**Wok box** tavolino /occasional table ..... **Ø35 H43**

---

---







MAPPLETHORPE Perfection in Form  
LIFE AT THE EDGE  
THE SWEDISH INTERIOR DESIGN LEGACY FROM SKERFVINGEN  
Art Space Tokyo





A solution devised to combine a desk and a wardrobe, even in confined spaces.

Una solución estudiada para combinar el escritorio con el armario, incluso en poco espacio.

Une solution conçue pour associer bureau et armoire, même dans un espace réduit.

Eine perfekte Lösung, um Schreibtisch und Schrank auch auf engem Raum zu kombinieren.

Решение, разработанное для сочетания письменного стола и шкафа, даже в небольшом пространстве.









Simple/  
Accessori  
intelligenti  
per una vita  
elegante







Intelligent accessories  
for an elegant lifestyle

Accesorios inteligentes  
para una vida elegante

Accessoires intelligents  
pour une vie élégante

Intelligente Accessoires  
für mehr Eleganz

Искусные принадлежности  
для элегантного стиля  
жизни





- Simple** scorrevole /sliding ..... L341,8 P67 H255,1  
 Laccato opaco Juta, Maniglia Nex, Laccato opaco Juta /  
 Matt Juta lacquer, Nex handle, matt Juta lacquer
- Morrison** letto /bed ..... L197 P229 H92
- Da-do system** comodino /night stand ..... L90 P45 H37,1
- Denny** pouf /footstool ..... Ø55/85 H42/37
- Tuft** tavolino /occasional table ..... Ø40,3/60,3 H46,3/36,8







SIMPLE

Alf DaFrè — MIXER





**Rubic/  
Un gioco  
di piani  
e volumi**

An exploration of shapes  
and surfaces

Un juego de superficies y  
volúmenes

Un jeu de plans et de  
volumes

Flächen und Volumen in  
Interaktion

Игра поверхностей и  
объемов



**Rubic** scorrevole /sliding

L341,8 P69 H255,1

Vetro lucido Calce, Profilo Laccato opaco Calce /  
Glossy Calce glass, matt Calce lacquer profile





Wood and lacquered surfaces create interesting shapes

Madera y superficies lacadas que crean formas especiales

Le bois et les surfaces laquées créent des géométries particulières

Holz und lackierte Oberflächen schaffen ein außergewöhnliches Muster

Дерево и крашенные поверхности в создании характерных форм

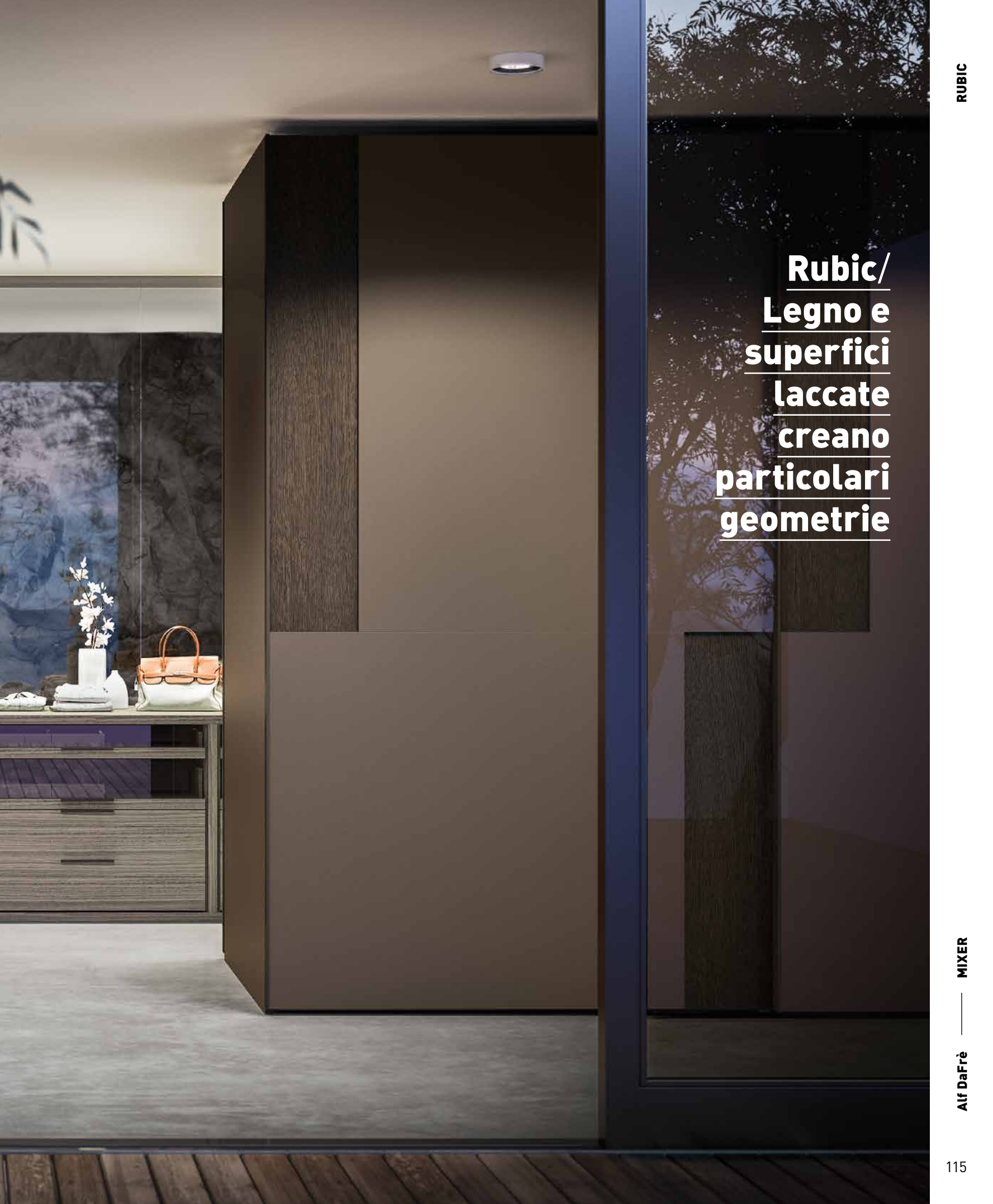

**Rubic/  
Legno e  
superfici  
laccate  
creano  
particolari  
geometrie**





.....  
**Rubic** scorrevole /sliding ..... L295,6 P138 (69x2) H255,1

Laccato opaco Fango, Fashion wood Rovere Carbone, Profilo Moka shine /  
 Matt Fango lacquer, Fashion Wood Carbone oak, Moka Shine profile

**Mixer** isola cassetti esterna /external drawers island ..... L384,6 (192,3x2) P100 H77,9

Eukalipto Cenere / Eukalipto Cenere

















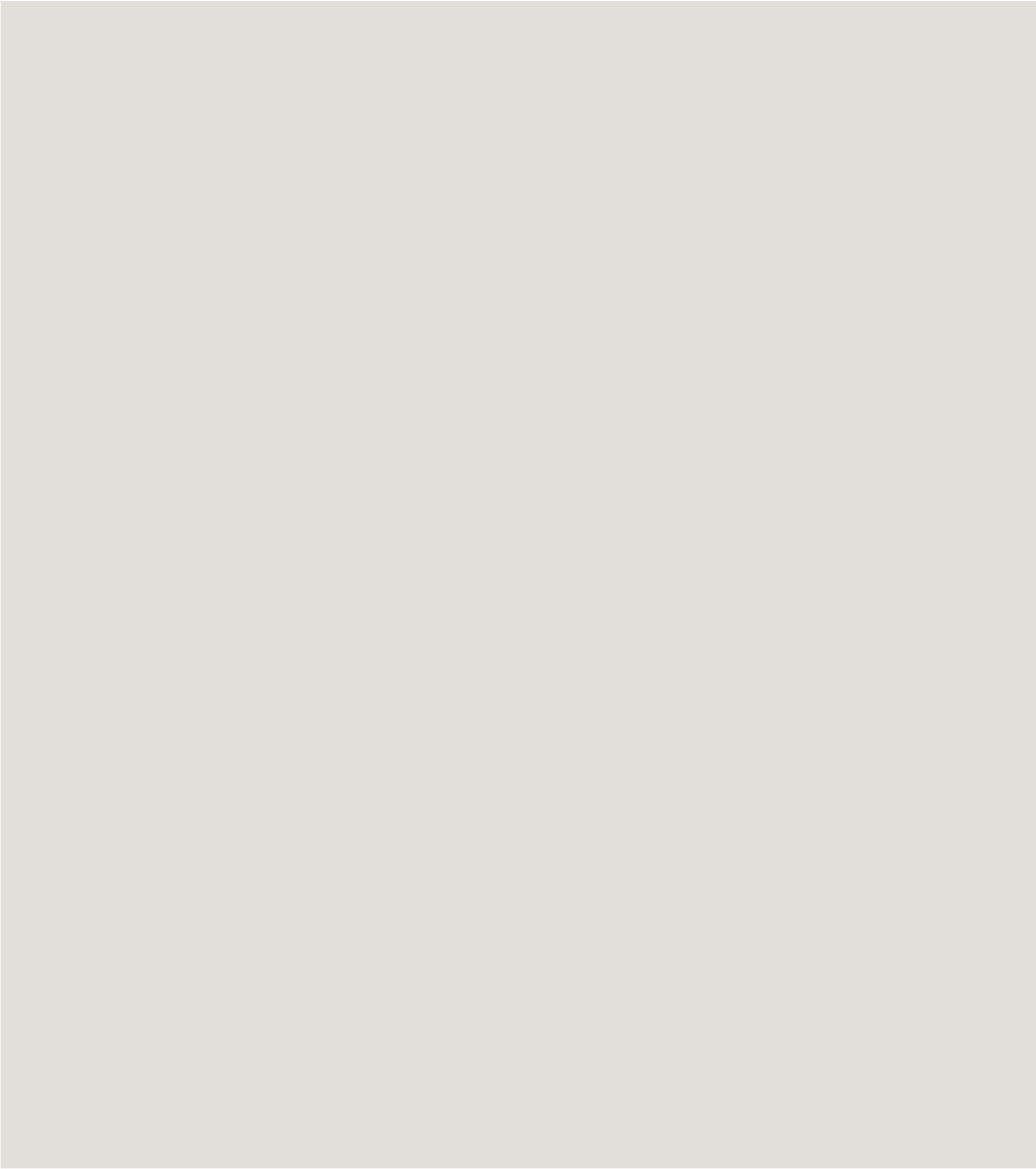





**Glide** p. 124

## **COMPLANARI**

**Coplanar**

**Glide**



**GLIDE/**  
**Complanarità**  
**ed essenzialità**  
**pura**



.....  
**Glide** complanare /coplanar ..... **L341,8 P62,3 H255,1**  
 Laccato opaco Platino / Matt Platino lacquer







Coplanar and utterly sleek

Coplanaridad y esencia pura

Coplanarité et essentiel pur

Die reine Schlichtheit der Geometrie

Компланарность и настоящая сущность





## **TIPOLOGIE ANTE**

Door type p. 130

## **MANIGLIE**

Handles p. 140

## **TIPOLOGIE DI APERTURA**

Types of opening p. 142

## **STRUTTURA ARMADIO**

Wardrobe structure p. 143

## **MODULARITÀ**

Modular units p. 144

## **ORGANIZZAZIONE DEGLI INTERNI**

Organising the inside p. 148

## **FINITURE INTERNE**

Internal finishes p. 150

## **ESEMPI DI ABBINAMENTO TRA SCOCCA, SCHIENA E ATTREZZATURE INTERNE**

Examples of combinations of bodies, back panels and internal fittings p. 152

## **DETTAGLI**

Details p. 154

## **ILLUMINAZIONE**

Lighting p. 155

## **TIPOLOGIE RIPIANI, COPERCHI, CASSETTI E VASSOI**

Types of shelves, cover tops, drawers and trays p. 158

## **FINITURE CASSETTI E VASSOI**

Drawer and tray finishes p. 162

## **ACCESSORI PER CASSETTI E VASSOI**

Accessories for drawers and trays p. 164

## **PROPOSTE ACCESSORI PER CASSETTI E VASSOI**

Examples of accessories for drawers and trays p. 165

## **ELEMENTI SOSPESI E SOLUZIONI PORTASCARPE**

Floating units and shoe rack solutions p. 166

## **RASTER**

Cubby-hole units p. 167

## **APPENDERIA**

Hanging rails p. 168

## **SPECCHI INTERNI**

Internal mirrors p. 170

## **ISOLA CASSETTI ESTERNA**

External drawer-unit island p. 171

## **MODULI**

Units p. 172

## **VETRI SERIGRAFATI**

Silk-screen printed glass p. 177

# Tipologie ante

/Door types  
/Tipos de puertas  
/Typologies de portes  
/Türentyp  
/Варианты створок

## Ante battenti

/Swinging doors

Le ante battenti sono dotate di cerniere con chiusura assistita\*.  
/The swinging doors are equipped with assisted-closing hinges\*.

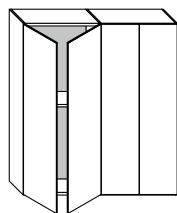

Sliver

## Ante battenti / scorrevoli

/Swinging/sliding doors

Le ante battenti sono dotate di cerniere con chiusura assistita\*.  
Le ante scorrevoli sono dotate di meccanismo per la chiusura assistita.  
/The swinging doors are equipped with assisted-closing hinges\*.  
The sliding doors are equipped with an assisted-closing mechanism.

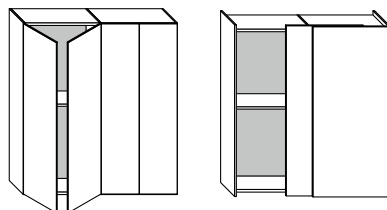

Display  
Rain  
Simple  
Split  
Strip

## Ante scorrevoli

/Sliding doors

Le ante scorrevoli sono dotate di meccanismo per la chiusura assistita.  
/The sliding doors are equipped with an assisted-closing mechanism.

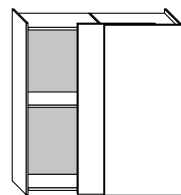

Frame  
Glide  
Quadra  
Rubic  
Vision

## Ante complanari

/Coplanar doors

Le ante complanari sono dotate di meccanismo per la chiusura assistita.  
/The coplanar doors are equipped with an assisted-closing mechanism.

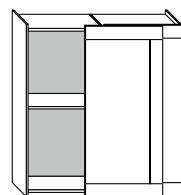

Glide

\*Tranne nei moduli spogliatoio, angolo, terminale / Except for dressing closet, corner and end units





## Ante battenti / scorrevoli

/Swinging/sliding doors  
 /Puertas batientes / correderas  
 /Portes battantes / coulissantes  
 /Drehtüren / Schiebetüren  
 /Распашные / раздвижные створки

### Display

Apertura battente /Swinging opening

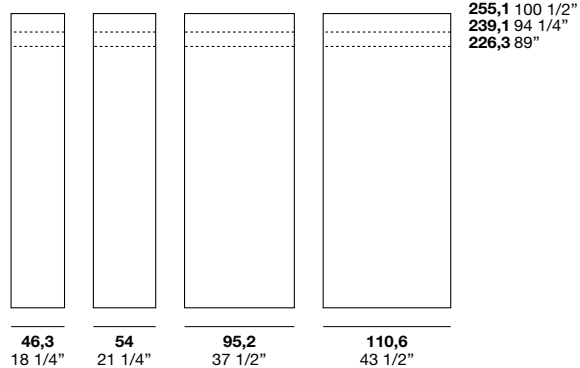

#### Finiture frontale / Front finishes:

Specchio / Mirror  
 Specchio Grigio / Grigio Mirror  
 Vetro Trasparente Grigio / Grigio transparent glass

#### Finiture telaio, maniglia integrata / Frame and built-in handle finishes:

Verniciato Moka shine / Painted Moka Shine

### Display

Apertura scorrevole / Sliding opening

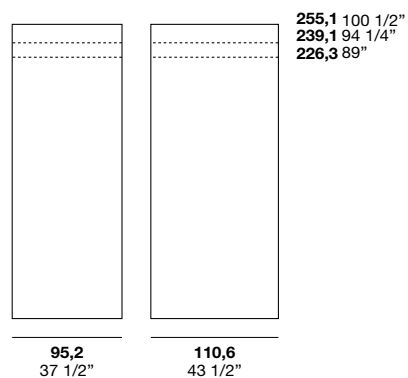

#### Finiture frontale / Front finishes:

Specchio / Mirror  
 Specchio Grigio / Grigio mirror  
 Vetro Trasparente Grigio / Grigio transparent glass

#### Finiture telaio, maniglia integrata / Frame and built-in handle finishes:

Verniciato Moka shine / Painted Moka Shine

## Rain

Apertura battente / Swinging opening

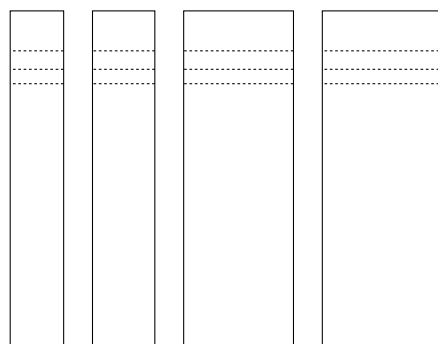

|                        |                      |                        |                         |
|------------------------|----------------------|------------------------|-------------------------|
| <b>46,3</b><br>18 1/4" | <b>54</b><br>21 1/4" | <b>95,2</b><br>37 1/2" | <b>110,6</b><br>43 1/2" |
|------------------------|----------------------|------------------------|-------------------------|

**290,3** 114 1/4"

**255,1** 100 1/2"

**239,1** 94 1/4"

**226,3** 89"

### Finiture frontale / Front finishes:

Fashion Wood / Fashion Wood

Roveri Laccati Opachi / Matt lacquered oak

Laccati Opachi Base (Bianco, Tortora) / Basic matt lacquer (Bianco, Tortora) Laccati Opachi / Matt lacquer

### Maniglie disponibili / Handles available

Pomolo

Pomolo Pelle

Nex

C16

T16

Elios

3D

G11

## Rain

Apertura scorrevole / Sliding opening

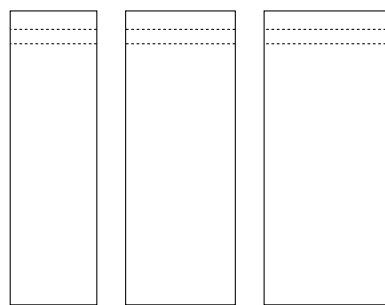
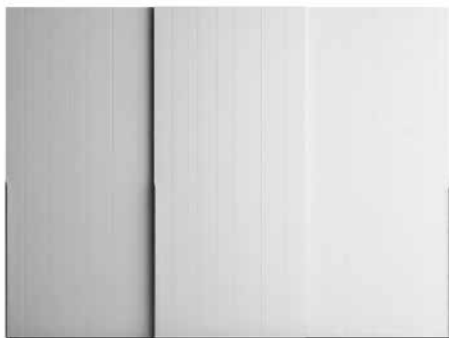

|                        |                        |                         |
|------------------------|------------------------|-------------------------|
| <b>75,2</b><br>29 1/2" | <b>95,2</b><br>37 1/2" | <b>110,6</b><br>43 1/2" |
|------------------------|------------------------|-------------------------|

**255,1** 100 1/2"

**239,1** 94 1/4"

**226,3** 89"

### Finiture frontale / Front finishes:

Fashion Wood / Fashion Wood

Roveri Laccati Opachi / Matt lacquered oak

Laccati Opachi Base (Bianco, Tortora) / Basic matt lacquer (Bianco, Tortora)

Laccati Opachi / Matt lacquer

### Maniglie disponibili / Handles available

Inner

Nex

C16

T16

3D

G11

# Ante battenti / scorrevoli

/Swinging/sliding doors  
 /Puertas batientes / correderas  
 /Portes battantes / coulissantes  
 /Drehtüren / Schiebetüren  
 /Распашные / раздвижные створки

## Simple

Apertura battente / Swinging opening

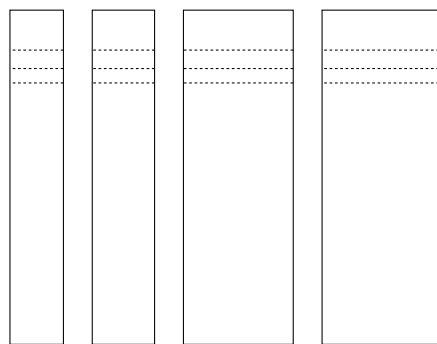

290,3 114 1/4"

255,1 100 1/2"

239,1 94 1/4"

226,3 89"

46,3  
18 1/4"

54  
21 1/4"

95,2  
37 1/2"

110,6  
43 1/2"

### Finiture frontale / Finiture frontale:

Fashion Wood / Fashion Wood  
 Roveri Laccati Opachi / Matt lacquered oak  
 Laccati Opachi Base (Bianco, Tortora) / Basic matt lacquer (Bianco, Tortora)  
 Laccati Opachi / Matt lacquer  
 Laccati Lucidi / High-gloss lacquer

### Maniglie disponibili / Handles available

Pomolo  
 Pomolo Pelle  
 Nex  
 C16  
 T16  
 Elios  
 3D  
 G11

## Simple

Apertura scorrevole / Sliding opening

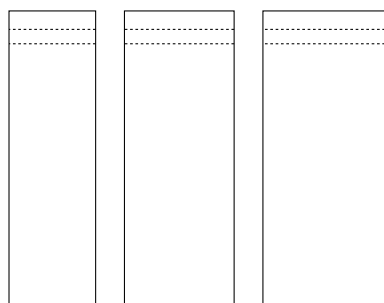

255,1 100 1/2"

239,1 94 1/4"

226,3 89"

75,2  
29 1/2"

95,2  
37 1/2"

110,6  
43 1/2"

### Finiture frontale / Front finishes:

Fashion Wood / Fashion Wood  
 Roveri Laccati Opachi / Matt lacquered oak  
 Laccati Opachi Base (Bianco, Tortora) / Basic matt lacquer (Bianco, Tortora)  
 Laccati Opachi / Matt lacquer  
 Laccati Lucidi / High-gloss lacquer

### Maniglie disponibili / Handles available

Inner  
 Nex  
 C16  
 T16  
 3D  
 G11



**Split**

Apertura battente / Swinging opening

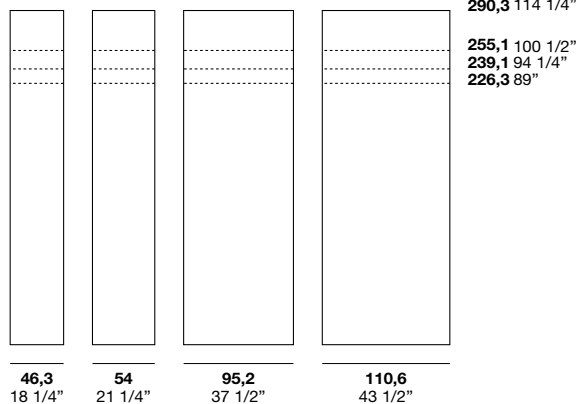
**Finiture frontale / Front finishes:**

Fashion Wood / Fashion Wood  
 Roveri Laccati Opachi / Matt lacquered oak  
 Laccati Opachi Base (Bianco, Tortora) / Basic matt lacquer (Bianco, Tortora)  
 Laccati Opachi / Matt lacquer  
 Laccati Lucidi / High-gloss lacquer

**Finiture maniglia integrata / Finiture maniglia integrata**

Verniciato Moka shine / Painted Moka Shine  
 Laccati Opachi / Matt lacquer

**Split**

Apertura scorrevole / Sliding opening

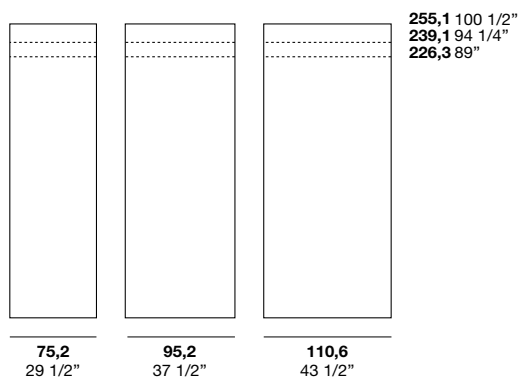

\*

**Finiture frontale / Front finishes:**

Fashion Wood / Fashion Wood  
 Roveri Laccati Opachi / Matt lacquered oak  
 Laccati Opachi Base (Bianco, Tortora) / Basic matt lacquer (Bianco, Tortora)  
 Laccati Opachi / Matt lacquer  
 Laccati Lucidi / High-gloss lacquer

**Finiture maniglia integrata / Integrated handle finishes**

Verniciato Moka shine / Painted Moka Shine  
 Laccati Opachi / Matt lacquer

\* L'anta esterna ha sempre due maniglie integrate / L'anta esterna ha sempre due maniglie integrate / the external door always has 2 integrated handles

# Ante battenti / scorrevoli

/Swinging/sliding doors  
 /Puertas batientes / correderas  
 /Portes battantes / coulissantes  
 /Drehtüren / Schiebetüren  
 /Распашные / раздвижные створки

## Strip

Apertura battente / Swinging opening

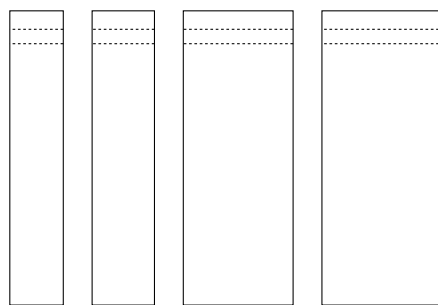

|                        |                      |                        |                         |
|------------------------|----------------------|------------------------|-------------------------|
| <b>46,3</b><br>18 1/4" | <b>54</b><br>21 1/4" | <b>95,2</b><br>37 1/2" | <b>110,6</b><br>43 1/2" |
|------------------------|----------------------|------------------------|-------------------------|

**255,1** 100 1/2"  
**239,1** 94 1/4"  
**226,3** 89"

### Finiture pannello / Panel finishes:

Fashion Wood / Fashion Wood  
 Roveri Laccati Opachi / Matt lacquered oak  
 Laccati Opachi Base (Bianco, Tortora) / Basic matt lacquer (Bianco, Tortora)  
 Laccati Opachi / Matt lacquer

### Finiture fascia maniglia / Handle strip finishes

Roveri Laccati Opachi / Matt lacquered oak  
 Laccati Opachi Base (Bianco, Tortora) / Basic matt lacquer (Bianco, Tortora)  
 Laccati Opachi / Matt lacquer  
 Laccati Lucidi / High-gloss lacquer

## Strip

Apertura scorrevole / Sliding opening

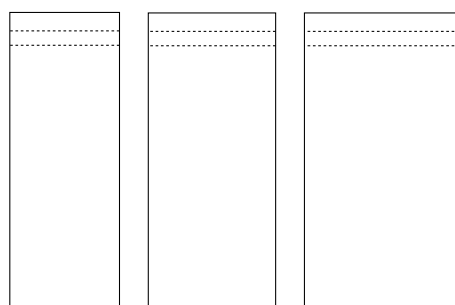

|                        |                         |                       |
|------------------------|-------------------------|-----------------------|
| <b>95,2</b><br>37 1/2" | <b>110,6</b><br>43 1/2" | <b>144</b><br>56 3/4" |
|------------------------|-------------------------|-----------------------|

**255,1** 100 1/2"  
**239,1** 94 1/4"  
**226,3** 89"

### Finiture pannello / Panel finishes:

Fashion Wood / Fashion Wood  
 Roveri Laccati Opachi / Matt lacquered oak  
 Laccati Opachi Base (Bianco, Tortora) / Basic matt lacquer (Bianco, Tortora)  
 Laccati Opachi / Matt lacquer

### Finiture fascia maniglia / Handle strip finishes

Roveri Laccati Opachi / Matt lacquered oak  
 Laccati Opachi Base (Bianco, Tortora) / Basic matt lacquer (Bianco, Tortora)  
 Laccati Opachi / Matt lacquer  
 Laccati Lucidi / High-gloss lacquer

# Ante scorrevoli

/Sliding doors  
/Puertas correderas  
/Portes coulissantes  
/Schiebetüren  
/Раздвижные створки

/technical data

## Vision

Apertura scorrevole /Sliding opening

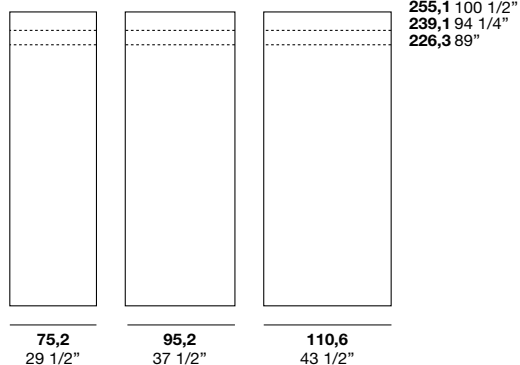
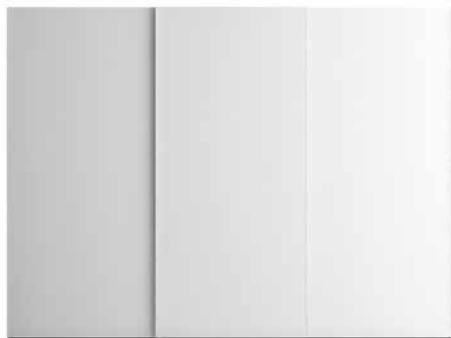

### Finiture frontale / Front finishes:

Fashion Wood / Fashion Wood  
Roveri Laccati Opachi / Matt lacquered oak  
Laccati Opachi Base (Bianco, Tortora) / Basic matt lacquer (Bianco, Tortora)  
Laccati Opachi / Matt lacquer  
Laccati Lucidi / High-gloss lacquer  
Specchio / Mirror  
Specchio Grigio / Grigio mirror  
Vetri Lucidi / High-gloss glass  
Vetri Acidati / Etched glass

### Finiture profilo, maniglia integrata / Profile and built-in handle finishes

Verniciato Moka shine / Verniciato Moka shine  
Laccati Opachi / Matt lacquer

## Frame

Apertura scorrevole /Sliding opening

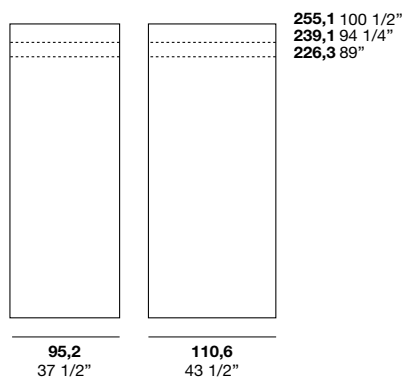

### Finiture pannello / Panel finishes:

Fashion Wood / Fashion Wood  
Roveri Laccati Opachi / Matt lacquered oak  
Laccati Opachi Base (Bianco, Tortora) / Basic matt lacquer (Bianco, Tortora)  
Laccati Opachi / Matt lacquer  
Specchio / Mirror  
Specchio Grigio / Grigio mirror  
Vetri Lucidi / High-gloss glass  
Vetri Acidati / Etched glass  
Vetri serigrafati / Silk-screen printed glass

### Finiture profilo, maniglia integrata / Profile and built-in handle finishes

Verniciato Moka shine / Painted Moka Shine  
Laccati Opachi / Matt lacquer

### Finiture fascia / Strip finishes

Fashion Wood / Fashion Wood  
Roveri Laccati Opachi / Matt lacquered oak  
Laccati Opachi Base (Bianco, Tortora) / Basic matt lacquer (Bianco, Tortora)  
Laccati Opachi / Matt lacquer  
Laccati Lucidi / High-gloss lacquer

MIXER  
—  
Alf DaFrè



# Ante scorrevoli

/Sliding doors  
/Puertas correderas  
/Portes coulissantes  
/Schiebetüren  
/Раздвижные створки

## Quadra

Apertura scorrevole / Sliding opening

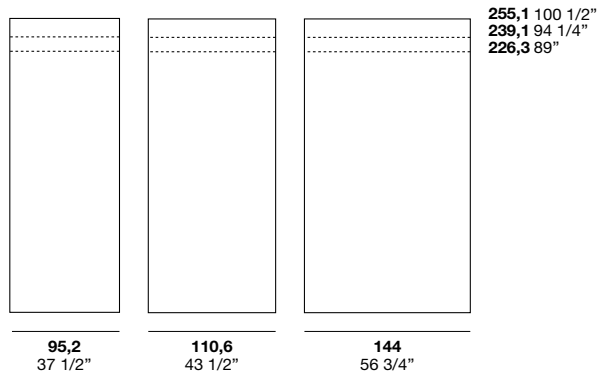
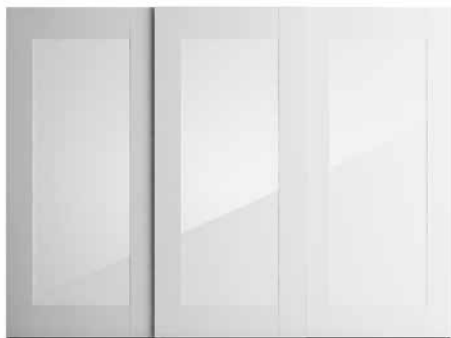

### Finiture pannello / Panel finishes:

Fashion Wood / Fashion Wood  
Roveri Laccati Opachi / Matt lacquered oak  
Laccati Opachi Base (Bianco, Tortora)  
/Basic matt lacquer (Bianco, Tortora)  
Laccati Opachi /Laccati Opachi  
High-gloss lacquer  
Specchio / Mirror  
Specchio Grigio / Grigio mirror  
Vetri Lucidi / High-gloss glass  
Vetri Acidati / Etched glass  
Ecopelli - Pelli / Faux leather - Leather\*

\* Il pannello ha quattro cuciture / The panel has 4 seams

### Finiture cornice / Frame finishes:

Fashion Wood / Fashion Wood  
Roveri Laccati Opachi / Matt lacquered oak  
Laccati Opachi Base (Bianco, Tortora)  
/Basic matt lacquer (Bianco, Tortora)  
Laccati Opachi /Laccati Opachi  
High-gloss lacquer

### Maniglia integrata / Built-in handle

Inner

## Rubic

Apertura scorrevole / Sliding opening

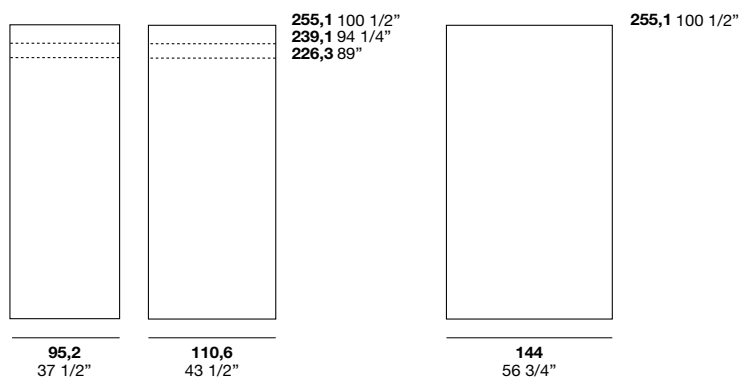

### Finiture pannelli grandi / Large panel finishes

Fashion Wood / Fashion Wood  
Roveri Laccati Opachi / Matt lacquered oak  
Laccati Opachi Base (Bianco, Tortora)  
/Basic matt lacquer (Bianco, Tortora)  
Laccati Opachi / Matt lacquer  
Laccati Lucidi / High-gloss lacquer  
Vetri Lucidi / High-gloss glass\*  
Vetri Acidati / Etched glass\*

### Finiture pannelli piccoli / Small panel finishes

Fashion Wood / Fashion Wood  
Roveri Laccati Opachi / Matt lacquered oak  
Laccati Opachi Base (Bianco, Tortora)  
/Basic matt lacquer (Bianco, Tortora)  
Laccati Opachi / Matt lacquer  
Laccati Lucidi / High-gloss lacquer  
Vetri Lucidi / High-gloss glass\*  
Vetri Acidati / Etched glass\*

### Finiture profilo, maniglia integrata / Profile and built-in handle finishes

Verniciato Moka shine / Painted Moka Shine  
Laccati Opachi / Matt lacquer

\* Nel caso di ante completamente vetro i pannelli grandi non sporgono rispetto ai pannelli piccoli  
/For full-glass doors, the large panels do not jut out with respect to the small panels

# Ante scorrevoli e complanari

/Sliding and coplanar doors  
 /Puertas correderas y coplanares  
 /Portes coulissantes et coplanaires  
 /Schiebetüren und komplanare Türen  
 /Раздвижные и компланарные створки

## Glide

Apertura scorrevole / Sliding opening

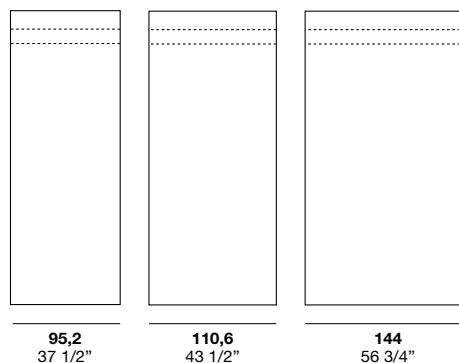
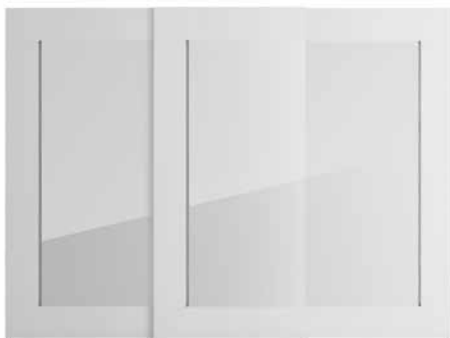

**Finiture pannello / Panel finishes**  
 Laccati Opachi Base (Bianco, Tortora)  
 /Basic matt lacquer (Bianco, Tortora)  
 Laccati Opachi / Matt lacquer  
 Laccati Lucidi / High-gloss lacquer

**Finiture fascia / Finiture fascia**  
 Laccati Opachi Base (Bianco, Tortora)  
 /Basic matt lacquer (Bianco, Tortora)  
 Laccati Opachi / Matt lacquer  
 Laccati Lucidi / High-gloss lacquer

**Finiture maniglia integrata / Integrated handle finishes**  
 Verniciato Moka shine / Painted Moka Shine  
 Laccati Opachi / Matt lacquer

Sempre corredata di maniglia Inner / Inner handle always used

## Glide

Apertura complanare / Coplanar opening

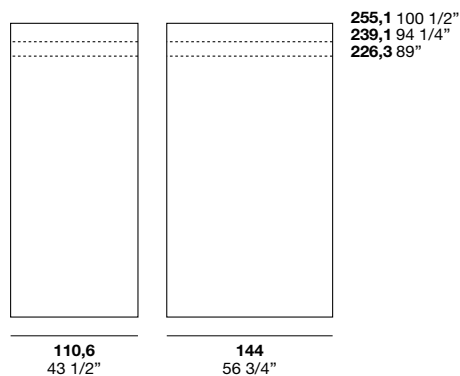
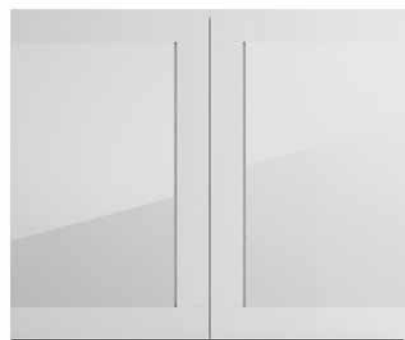

**Finiture pannello / Panel finishes**  
 Laccati Opachi Base (Bianco, Tortora)  
 /Basic matt lacquer (Bianco, Tortora)  
 Laccati Opachi / Matt lacquer  
 Laccati Lucidi / High-gloss lacquer

**Finiture fascia / Strip finishes**  
 Laccati Opachi Base (Bianco, Tortora)  
 /Basic matt lacquer (Bianco, Tortora)  
 Laccati Opachi / Matt lacquer  
 Laccati Lucidi / High-gloss lacquer

**Finiture maniglia integrata / Integrated handle finishes**  
 Verniciato Moka shine / Painted Moka Shine  
 Laccati Opachi / Matt lacquer

# Maniglie

/Handles  
/Tiradores  
/Poignées  
/Griffe  
/Ручки



## Pomolo

Maniglia per anta battente.  
Finiture: Nichel satinato.  
/Handle for swinging door.  
Finishes: satin-finish nickel.



## Pomolo pelle

Maniglia per anta battente.  
Finiture: verniciato Moka shine e cuoio grigio.  
/Handle for swinging door.  
Finishes: painted Moka Shine and Grigio leather.



## Nex

Maniglia per anta battente e scorrevole. Finiture:  
laccati opachi, verniciato Moka shine.  
/Handle for swinging and sliding door. Finishes:  
matt lacquer, painted Moka Shine.



## C16

Maniglia per anta battente e scorrevole. Finiture:  
laccati opachi, verniciato Moka shine.  
/Handle for swinging and sliding door. Finishes:  
matt lacquer, painted Moka Shine.



## T16

Maniglia per anta battente e scorrevole. Finiture:  
laccati opachi, verniciato Moka shine.  
/Handle for swinging and sliding door. Finishes:  
matt lacquer, painted Moka Shine.



## Elios

Maniglia per anta battente.  
Finiture: laccati opachi, laccati lucidi, fashion  
wood, roveri laccati opachi.  
/Handle for swinging door.  
Finishes: matt lacquer, high-gloss lacquer,  
Fashion Wood, matt lacquered oak.





**Inner**  
Maniglia per anta scorrevole.  
Finiture: Nichel satinato.  
/Handle for sliding door.  
Finishes: satin-finish nickel.



**3D**  
Maniglia per anta battente e scorrevole. Finiture:  
laccati opachi, verniciato Moka shine  
/Handle for swinging and sliding door. Finishes:  
matt lacquer, painted Moka Shine.



**G11**  
Maniglia per anta battente e scorrevole. Finiture:  
laccati opachi, verniciato Moka shine.  
/Handle for swinging and sliding door. Finishes:  
matt lacquer, painted Moka Shine.

# Tipologie di apertura

/Types of opening  
/Tipos de apertura  
/Typologies d'ouverture  
/Öffnungsarten  
/Варианты открытия

## Battente / Swinging

Le ante battenti sono dotate di  
cerniere con chiusura assistita\*  
/The swinging doors are  
equipped with assisted-closing hinges\*

### ante /doors

Display  
Rain  
Simple  
Sliver  
Split  
Strip

\* Tranne nei moduli spogliatoio, angolo, terminale  
/Except for dressing closet, corner and end units

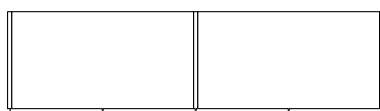
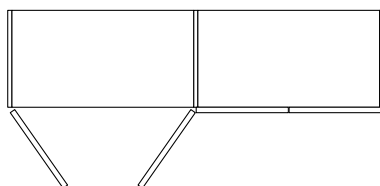
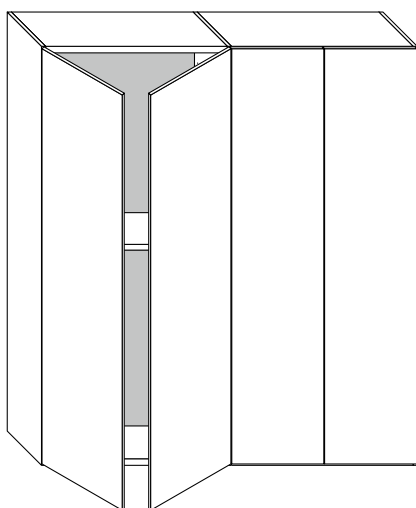

## Scorrevole / Sliding

Le ante scorrevoli sono dotate di  
meccanismo per la chiusura assistita.  
/The sliding doors are equipped  
with an assisted-closing mechanism.

### ante /doors

Display  
Vision  
Frame  
Quadra  
Rain  
Simple  
Split  
Strip  
Rubic  
Glide

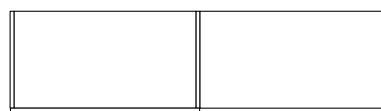
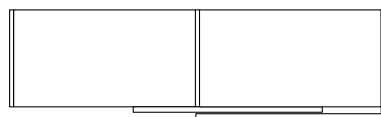
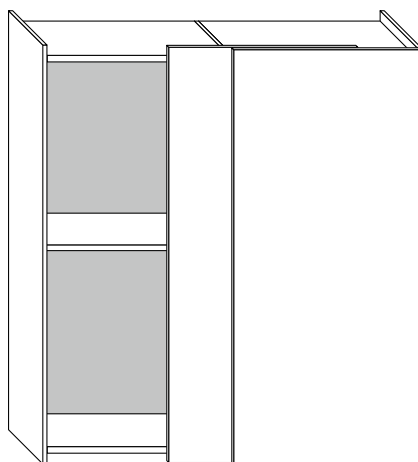

## Complanare / Coplanar

Le ante complanari sono dotate di  
meccanismo per la chiusura assistita.  
/The coplanar doors are equipped  
with an assisted-closing mechanism.

### ante /doors

Glide

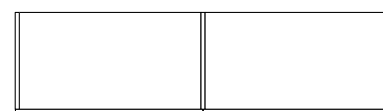
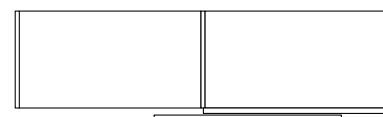
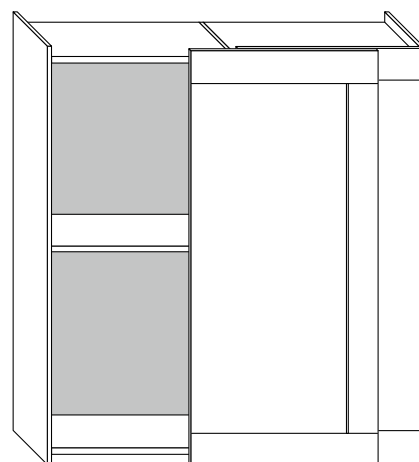

## Plus ante scorrevoli e complanari / Plus sliding and coplanar doors

La progettazione dei nostri armadi con apertura scorrevole o complanare permette,  
in configurazione chiusa, la totale sovrapposizione delle ante ai fianchi.  
/The design of our wardrobes with a sliding or coplanar opening means that  
the doors fully overlap with the side panels when closed.

# Struttura armadio

/Wardrobe structure  
/Estructura del armario  
/Structure armoire  
/Korpus Schrank  
/Каркас шкафа

/technical data

## Struttura battente / Swinging structure

- 1 - Fianco  
/Side panel
- 2 - Divisione  
/Partition
- 3 - Coperchio  
/Top
- 4 - Schiena  
/Back panel
- 5 - Fondo  
/Bottom
- 6 - Ripiano  
/Shelf
- 7 - Tubo appendiabiti  
/Clothes rail

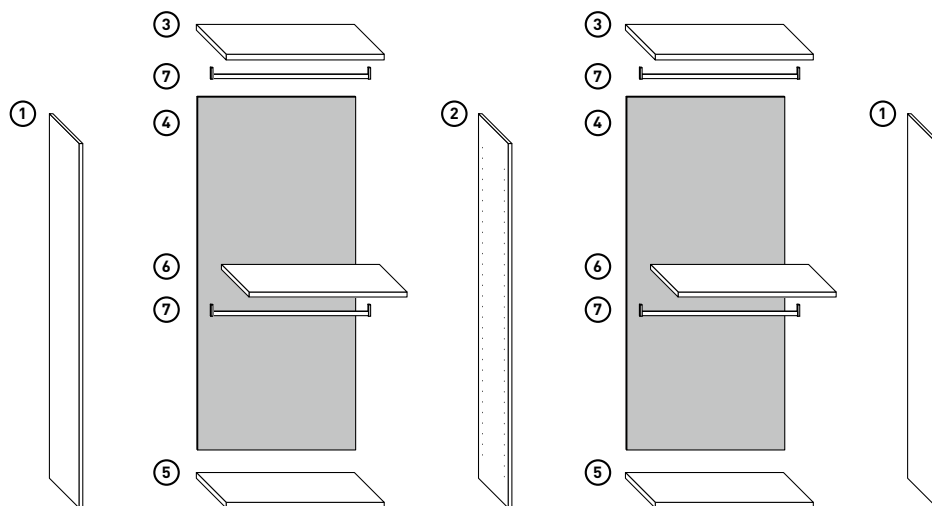

## Struttura scorrevole, coplanare / Sliding, coplanar structure

- 1 - Fianco  
/Side panel
- 2 - Divisione scorrevole  
/Sliding partition
- 3 - Divisione coplanare  
/Coplanar partition
- 4 - Coperchio  
/Top
- 5 - Schiena  
/Schiena
- 6 - Fondo  
/Bottom
- 7 - Ripiano  
/Shelf
- 8 - Tubo appendiabiti  
/Clothes rail
- 10 - Binario superiore coplanare  
/Upper coplanar track
- 11 - Binario inferiore scorrevole  
/Lower sliding track
- 12 - Binario inferiore coplanare  
/Lower coplanar track
- 13 - Barra di rinforzo  
/Support bar

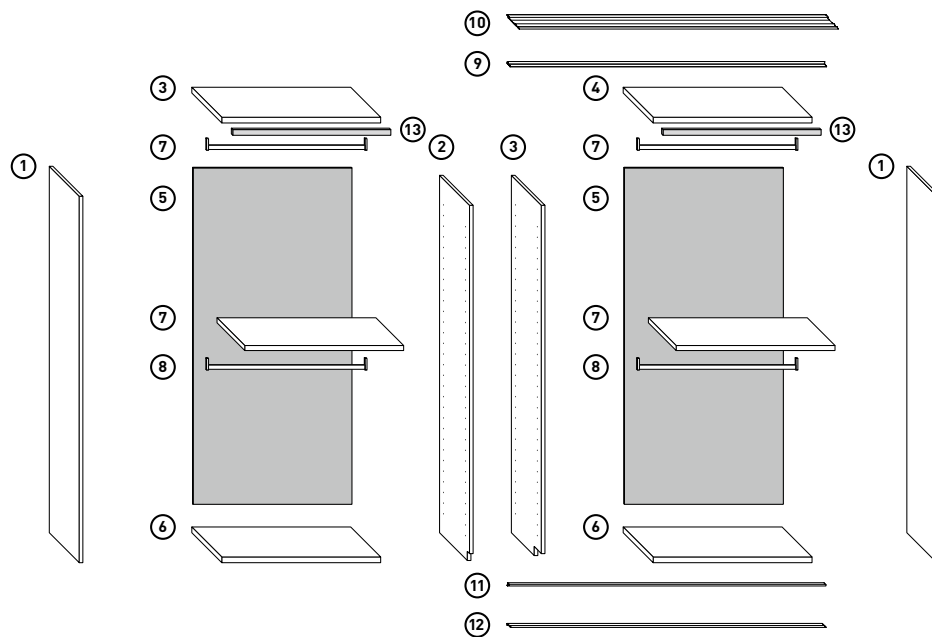

## Tipologie ripiani / Types of shelving

- 1 - Ripiano  
/Shelf
- 2 - Ripiano in vetro trasparente grigio con telaio alluminio finitura grigio fumo  
/Grigio transparent glass shelf with aluminium frame, Grigio Fumo finish
- 3 - /Ripiano in vetro trasparente grigio con telaio alluminio finitura grigio fumo e luce a led  
/Grigio transparent glass shelf with aluminium frame, Grigio Fumo finish and LED light



MIXER  
—  
Alf DaFrè



# Modularità battente

/Swinging modular units  
 /Modularidad puerta batiente  
 /Modularité battante  
 /Module Drehtür  
 /Модульность распашных шкафов

## Altezze / Heights

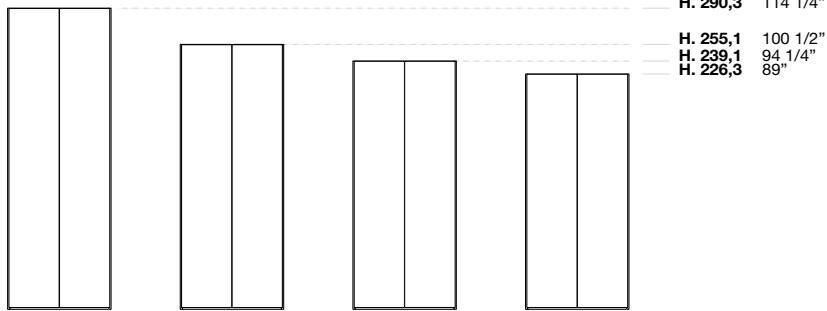

## Moduli / Units

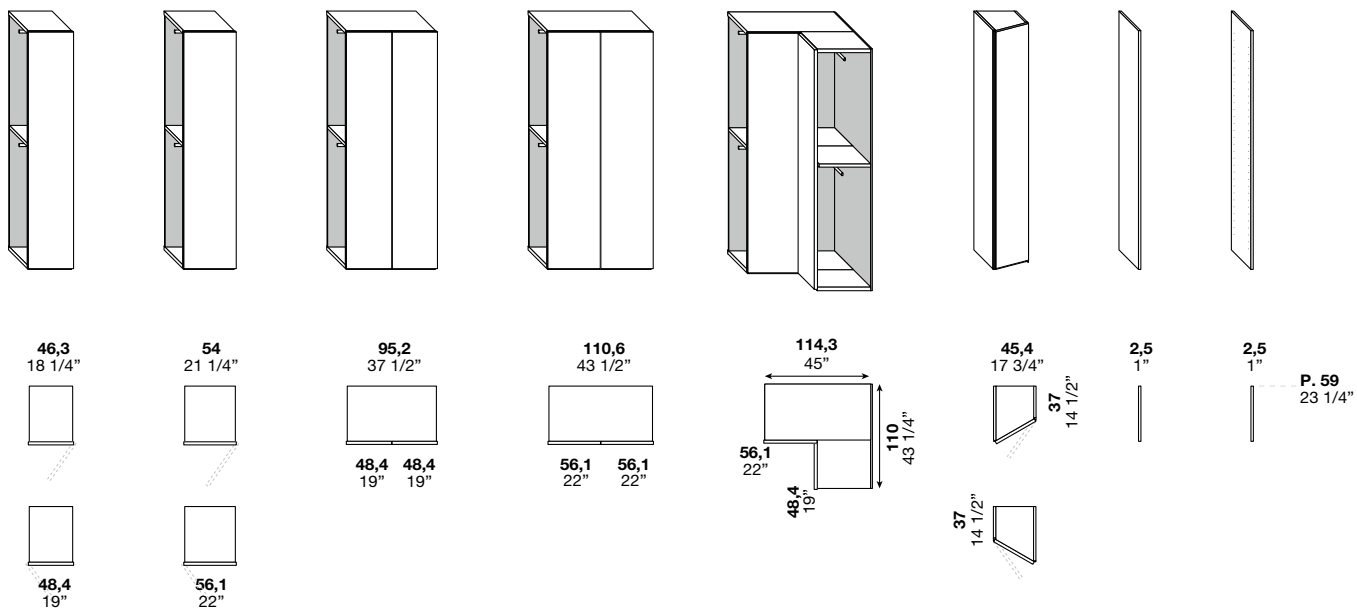

Vani a giorno / Open compartments

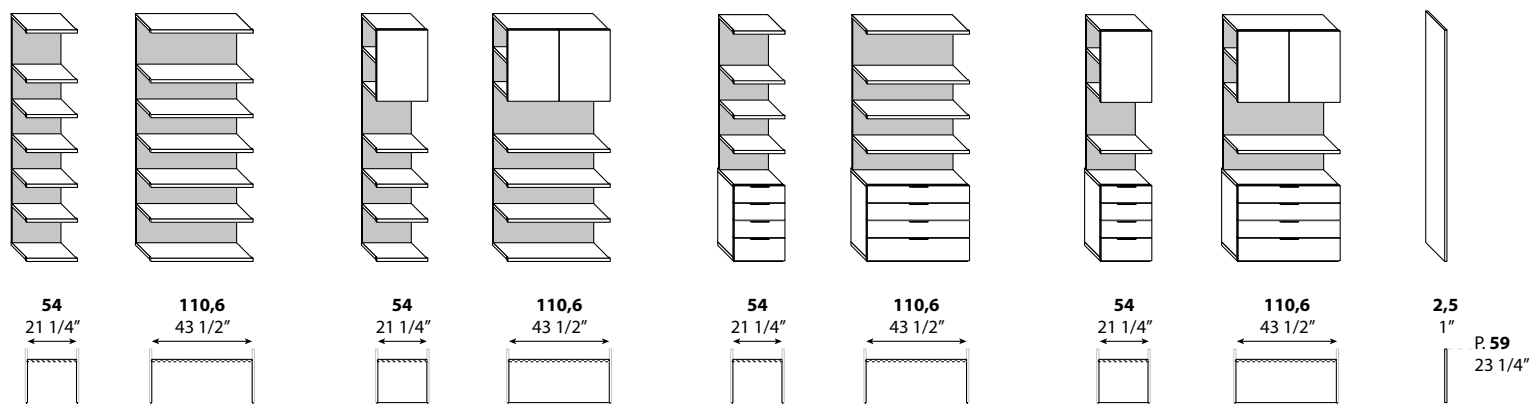

Ponti / Bridges

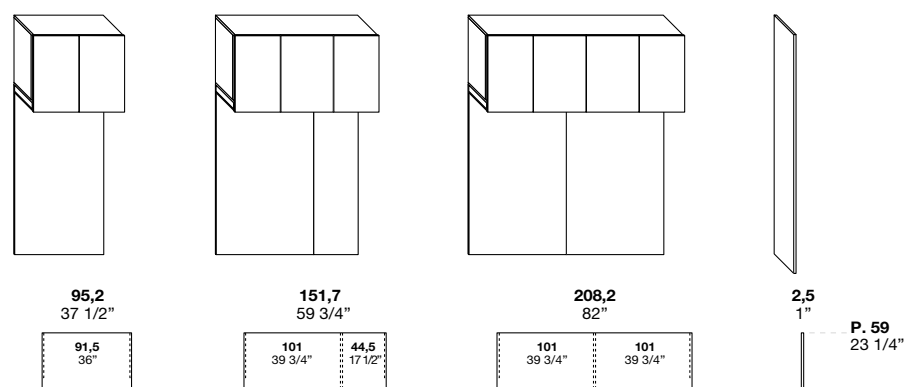

Spogliatoi / Dressing closets

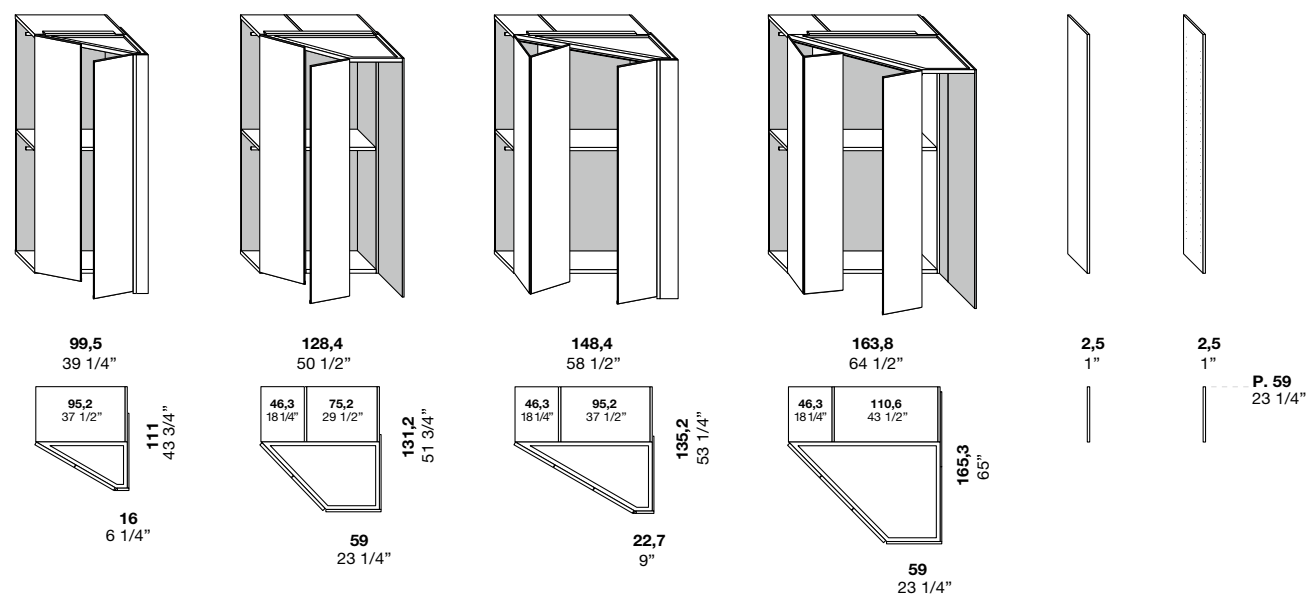

# Modularità scorrevole

/Sliding modular units  
 /Modularidad puerta corredera  
 /Modularité coulissante  
 /Module Schiebetür  
 /Модульность раздвижных шкафов

## Altezze / Heights

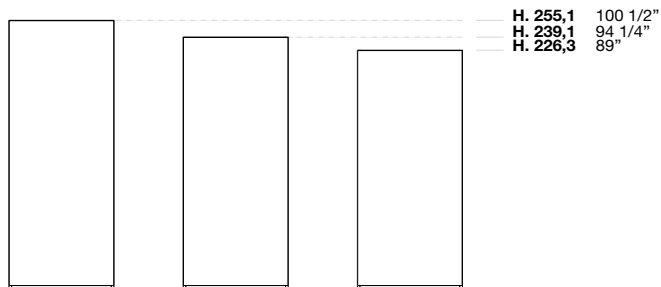

## Moduli / Units

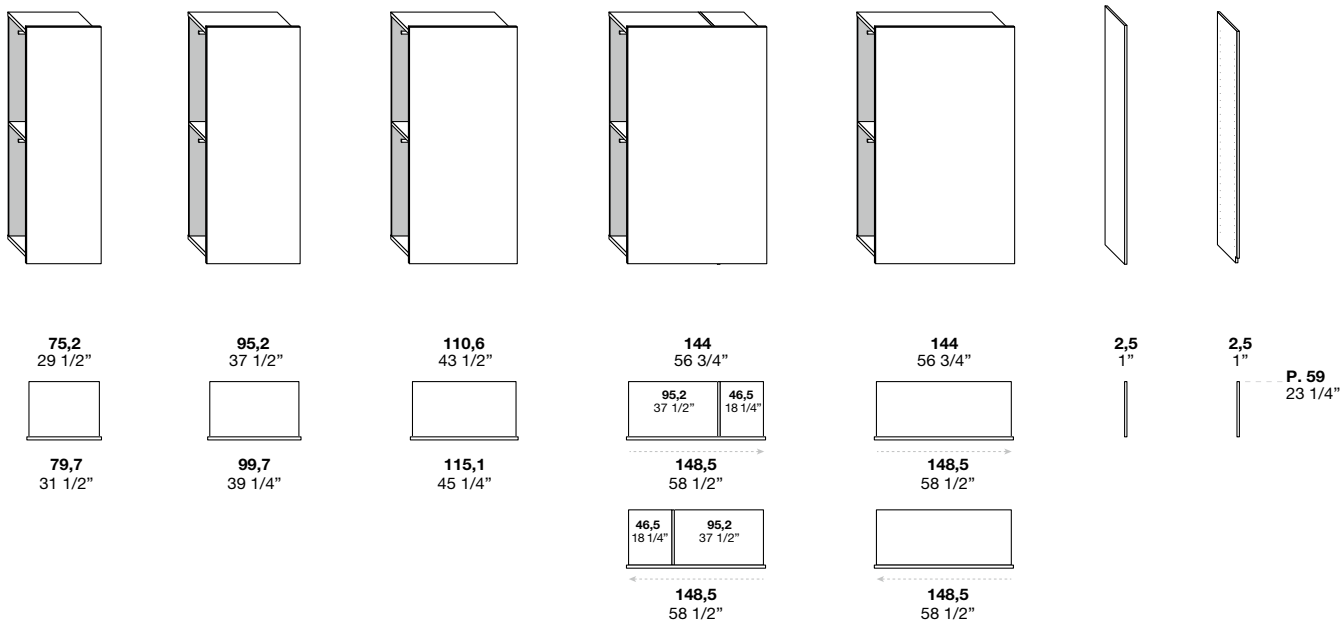



# Modularità complanare

/Coplanar modular units  
 /Modularidad coplanar  
 /Modularité coplanaire  
 /Module komplanare Türen  
 /Модульность компланарных шкафов

## Altezze / Heights

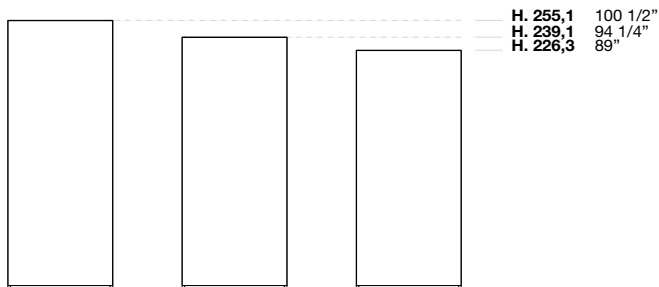

## Moduli / Units

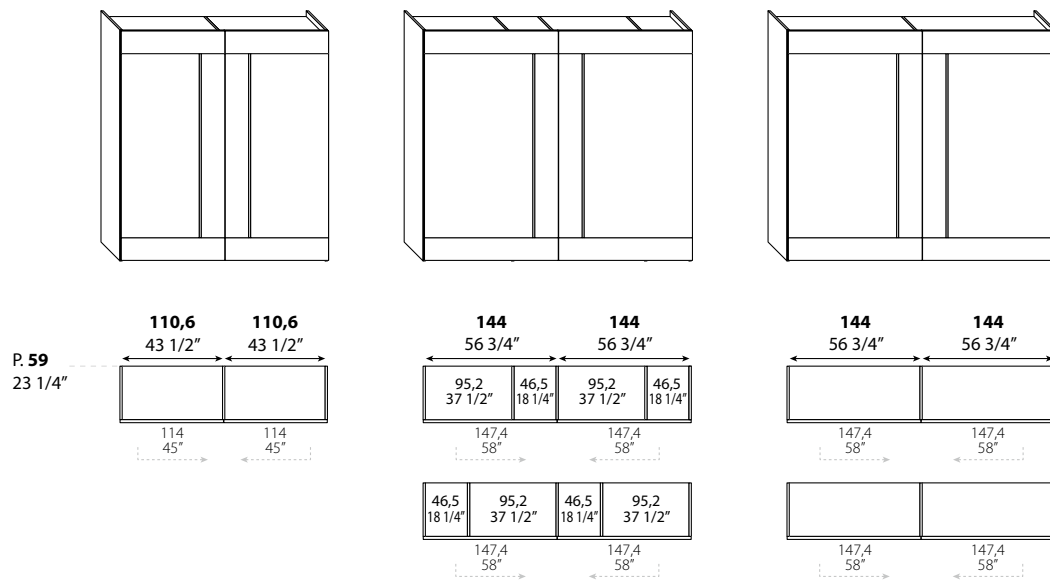

L'armadio complanare è disponibile solo in configurazione 2 ante, la configurazione 4 ante è formata dall'accostamento di 2 armadi (in tal caso si avranno 2 fianchi affiancati per l'unione dei 2 moduli)  
 /The coplanar wardrobe is only available in the 2-door configuration; the 4-door configuration is created by positioning 2 wardrobes side by side (this means there are 2 side panels next to each other where the 2 units join)

# Organizzazione degli interni

/Organising the inside  
 /Organización de los interiores  
 /Organisation des intérieurs  
 /Organisation des Stauraums  
 /Организация внутреннего оснащения



1 tubo appendiabiti  
 /1 clothes rail

1 cassettera sospesa con  
 vassoio estraibile H 11 cm  
 /1 floating drawer-unit with  
 pull-out drawer H. 11 cm

1 tubo appendiabiti  
 /1 clothes rail

1 cassettera sospesa  
 con vassoio e portagonne  
 estraibili H 5 cm  
 /1 floating drawer-unit with  
 pull-out tray and skirt rack  
 H. 5 cm

1 ripiano  
 /1 shelf

1 tubo appendiabiti  
 /1 clothes rail  
 1 cassettera con ripiani con  
 6 cassetti bassi  
 frontale legno H 12,4 cm  
 /1 drawer-unit with shelves  
 and 6 shallow drawers,  
 wood front H. 12.4 cm

4 ripiani  
 /4 shelves

1 cassettera con  
 4 cassetti alti frontale legno  
 H 18,8 cm  
 /1 drawer-unit with  
 4 deep drawers, wood front  
 H. 18.8 cm

2 scatole con coperchio  
 rivestite in tessuto L 40 cm  
 /2 fabric-covered boxes with  
 lid W. 40 m

1 ripiano  
 /1 shelf

1 tubo appendiabiti  
 /1 clothes rail

1 cassettera sospesa con  
 3 vassoi bassi a giorno H  
 12,4 cm  
 /1 floating drawer unit with  
 3 open-fronted trays, H. 12.4  
 cm

2 scatole con coperchio  
 rivestite in tessuto L 40 cm  
 /2 fabric-covered boxes with  
 lid W. 40 m



2 scatole con coperchio  
rivestite in tessuto L 40 cm  
/2 fabric-covered boxes with  
lid W. 40 m

1 ripiano  
/1 shelf

1 tubo appendiabiti  
/1 tubo appendiabiti

1 cassettera sospesa con  
3 vassoi bassi a giorno H  
12,4 cm  
/1 floating drawer unit with  
3 open-fronted trays, H. 12.4  
cm

2 scatole con coperchio  
rivestite in tessuto L 40 cm  
/2 fabric-covered boxes with  
lid W. 40 m

1 ripiano  
/1 shelf

1 ripiano vetro con luce  
led  
/1 glass shelf with LED light

1 raster con 3 scatole basse  
rivestite in tessuto H 8,8 cm  
/1 cubby-hole unit with 3  
shallow fabric-covered boxes  
H. 8.8 cm

1 cassettera sospesa con  
2 vassoi bassi con frontale  
vetro H 12,4 cm  
/1 floating drawer unit with  
2 shallow trays with a glass  
front, H. 12.4 cm

1 ripiano vetro con luce led  
/1 glass shelf with LED light

3 scatole alte rivestite in  
tessuto H 15 cm  
/3 deep fabric-covered boxes  
H. 15 cm

4 ripiani  
/4 shelves

1 portascarpe  
/1 shoe rack

1 tubo appendiabiti  
/1 clothes rail

1 raster con scatole alte  
rivestite in tessuto H 15 cm  
/1 cubby-hole unit with deep  
fabric-covered boxes H. 15  
cm

1 cassettera con 6 cassetti  
bassi frontale legno  
H 12,4 cm  
/1 drawer unit with 6 shallow  
drawers with a wood front, H.  
12.4 cm

1 tubo appendiabiti  
/1 tubo appendiabiti

1 divisorio con ripiani e tubo  
appendiabiti  
/1 partition with shelves and  
a clothes rail



# Finiture interne

/Internal finishes  
/Acabados internos  
/Finitions intérieures  
/Innenausführungen  
/Внутренняя отделка



Decor Tortora  
/Tortora Decor



Decor Arena  
/Arena Decor



Eukalipto Cenere  
/Eukalipto Cenere



Rovere Bruno  
/Bruno oak



Decor laccati opachi  
/Matt lacquered Decor



Coperchio - Fondo - Fianco - Divisione  
/Top - Bottom - Side - Partition



Decor Tortora  
/Tortora Decor



Decor Arena  
/Arena Decor

Ripiano - Schiena  
/Shelf - Back panel



Decor Tortora  
/Tortora Decor



Decor Arena  
/Arena Decor



Eukalipto Cenere  
/Eukalipto Cenere



Rovere Bruno  
/Bruno oak



Decor laccati opachi  
/Matt lacquered Decor



Raster - Cassettera - Portascarpe (telaio finitura moka shine)  
/Cubby-hole unit - Drawer unit - Shoe rack (Moka Shine finish on frame)

Casettiera con vassoio estraibile (telaio finitura grigio fumo) -  
Casettiera con ripiani  
/Drawer unit with pull-out tray (Grigio Fumo finish on frame)  
Drawer unit with shelves

Vassoio estraibile (telaio finitura grigio fumo) -  
Casettiera con ripiani  
/Pull-out tray (Grigio Fumo finish on frame) -  
Drawer unit with shelves



Decor Tortora  
/Tortora Decor



Decor Arena  
/Arena Decor



Eukalipto Cenere  
/Eukalipto Cenere

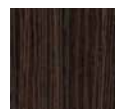

Rovere Bruno  
/Bruno oak



Decor laccati opachi  
/Matt lacquered Decor



## Esempi di abbinamenti tra scocca, schiena e attrezzature interne

/Examples of combinations of bodies, back panels and internal fittings  
/Ejemplos de combinaciones entre estructura, trasera y equipamientos internos  
/Exemples d'associations entre structure, fond et équipements internes  
/Beispiele für die Kombination von Korpus, Rückwand und Innenausstattung  
/Примеры сочетаний каркаса, задней стенки и внутреннего оснащения



- 1 - Scocca Decor Tortora  
/Tortora Decor body
- 2 - Scocca Decor Arena  
/Arena Decor body
- 3 - Schiena Decor Tortora  
/Tortora Decor back panel
- 4 - Schiena Decor Arena  
/Arena Decor back panel
- 5 - Schiena Eukalipto Cenere  
/Eukalipto Cenere back panel
- 6 - Schiena Rovere Bruno  
/Bruno oak back panel
- 7 - Attrezzatura interna Decor Tortora  
/Tortora Decor internal fittings
- 8 - Attrezzatura interna Decor Arena  
/Attrezzatura interna Decor Arena
- 9 - Attrezzatura interna Eukalipto Cenere  
/Eukalipto Cenere internal fittings
- 10 - Attrezzatura interna Rovere Bruno  
/Bruno oak internal fittings







Disponibile anche in Decor laccati opachi / Also available in matt lacquered Decor

## Dettagli

/Details  
/Détalles  
/Détails  
/Details  
/Детали



Tappino in tinta per decor Tortora  
/Plugs to match Tortora Decor



Tappino in tinta per decor Arena  
/Plugs to match Arena Decor



Cerniera  
/Hinge



Cerniera a perno per anta Display in finitura verniciato Moka shine  
/Pin hinge for Display door in painted Moka Shine finish

# illuminazione

/Lighting  
/Iluminación  
/Éclairage  
/Beleuchtung  
/Подсветка

/technical data



Barra luce led in alluminio finitura Moka Shine per coperchio  
/Aluminium LED strip in Moka Shine finish for top



Ripiano vetro trasparente grigio con telaio alluminio finitura grigio fumo con luce led  
/Grigio transparent glass shelf with aluminium frame in Grigio Fumo finish with LED light

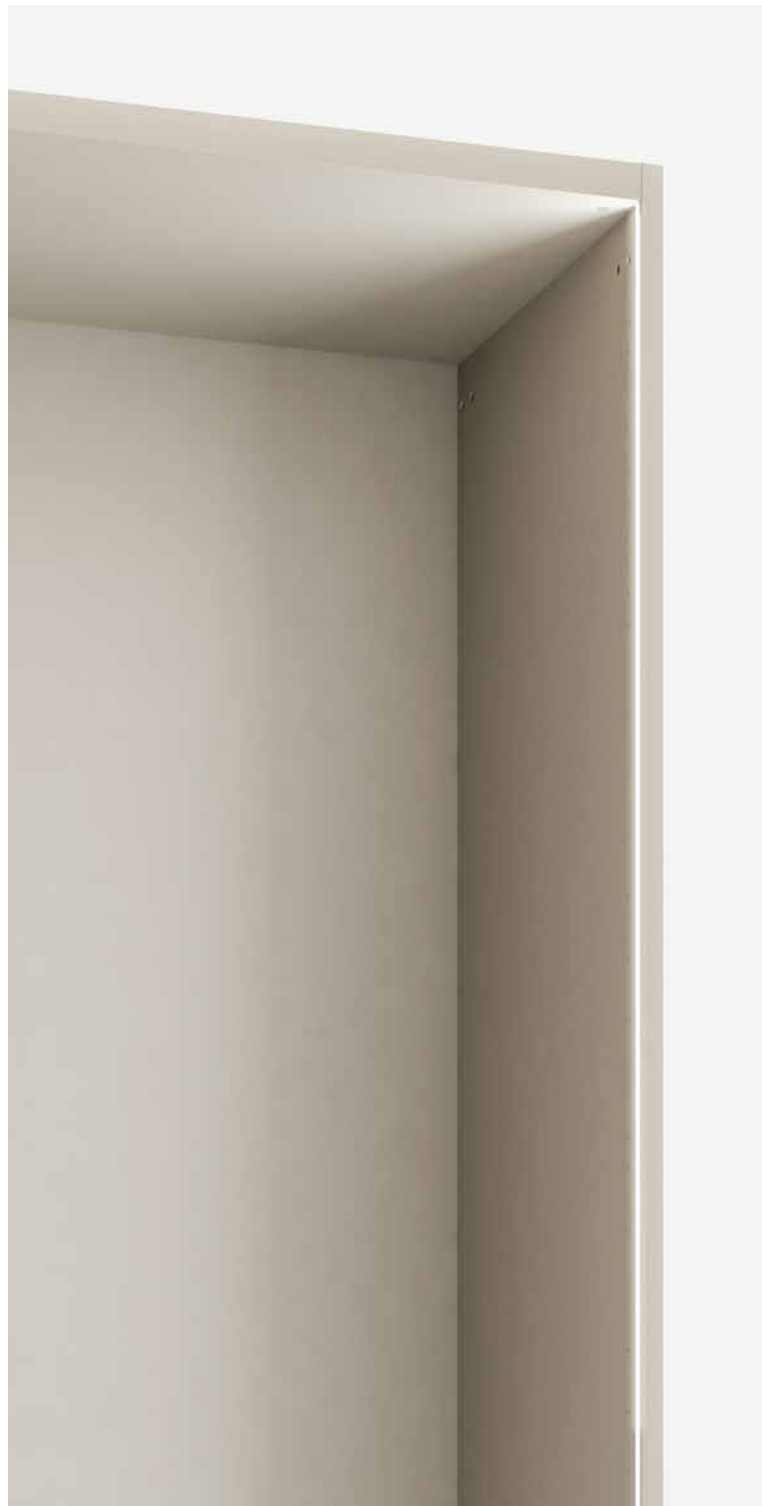

Barra luce led incassata per fianco o divisione  
/Built-in LED strip for side panels or partitions

Alf DaFrè — MIXER



## Ripiani

---

/Shelves  
/Baldas  
/Étagères  
/Fachböden  
/Полки

---





# Tipologie ripiani

/Types of shelving  
/Tipos de baldas  
/Typologies d'étagères  
/Typologie Fachböden  
/Варианты полок

Ripiano  
/Shelf



Ripiano vetro trasparente grigio con telaio alluminio  
finitura grigio fumo  
/Grigio transparent glass shelf with aluminium  
frame, Grigio Fumo finish



Ripiano vetro trasparente grigio con telaio alluminio  
finitura grigio fumo con luce led  
/Grigio transparent glass shelf with aluminium  
frame in Grigio Fumo finish with LED light





## Tipologie coperchi

/Types of tops  
/Tipos de tapas  
/Typologies de dessus  
/Typologie Deckelböden  
/Варианты верхних панелей

/technical data

Coperchio  
/Top



Coperchio portaoggetti  
/Storage unit top



Entrambi disponibili per:  
- cassettiere  
- vassoi estraibili  
- cassettiere con ripiani  
/Both available for:  
- drawer units  
- pull-out trays  
- drawer units with shelves

Alf DaFrè — MIXER

## Tipologie cassetti e vassoi

---

/Types of drawers and trays  
/Tipos de cajones y bandejas  
/Typologies de tiroirs et plateaux  
/Typologie Schubladen und Ablagen  
/Варианты ящиков и лотков

---

Cassetto alto con frontale in legno H 18,8 cm  
/Deep drawer with wood front, H. 18.8 cm



Vassoio alto con frontale vetro trasparente grigio H 18,8 cm  
/Deep tray with Grigio transparent glass front, H. 18.8 cm



Vassoio alto a giorno H 18,8 cm  
/Open-fronted deep tray, H. 18.8 cm



Cassetto basso con frontale in legno H 12,4 cm  
/Shallow drawer with wood front, H. 12.4 cm



Vassoio basso con frontale vetro trasparente grigio  
H 12,4 cm  
/Shallow tray with Grigio transparent glass front, H. 12.4 cm



Vassoio basso a giorno H 12,4 cm  
/Open-fronted shallow tray, H. 12.4 cm



I cassetti e i vassoi sono dotati di guide con chiusura assistita.  
/The drawers and trays are fitted with assisted-closing runners.



## Finiture cassetti / vassoi con frontale vetro / vassoi a giorno

/Finishes for drawers/trays with a glass front/open-fronted trays  
/Acabados de cajones / bandejas con frontal de cristal / bandejas abiertas  
/Finitions des tiroirs / plateaux avec façade en verre / plateaux ouverts  
/Ausführungen Schubladen / Ablagen mit Glasfront / offene Ablagen  
/Отделка ящиков / лотков с передней стеклянной панелью / открытых лотков



Cassetto con frontale in legno e interno in polimerico  
/Drawer with wooden front and polymer inside



Vassoio con frontale in vetro trasparente grigio  
/Tray with Grigio transparent glass front



Vassoio a giorno  
/Open-fronted tray



Decor Tortora  
/Tortora Decor



Decor Arena  
/Arena Decor



Eukalipto Cenere  
/Eukalipto Cenere



Rovere Bruno  
/Bruno oak



Decor laccati opachi  
/Matt lacquered Decor

## Finiture vassoi estraibili con telaio alluminio

/Finishes for pull-out trays with an aluminium frame  
 /Acabados de bandejas extraíbles con estructura de aluminio  
 /Finitions de plateaux extractibles avec cadre en aluminium  
 /Ausführungen ausziehbare Ablagen mit Aluminiumrahmen  
 /Отделка выдвигаемых лотков с алюминиевой рамкой



Vassoio in alluminio grigio fumo con fondo in  
 finitura H 5 cm  
 /Grigio Fumo aluminium tray with finished bottom  
 H. 5 cm

Vassoio in alluminio grigio fumo con fondo in  
 finitura H 11 cm  
 /Grigio Fumo aluminium tray with finished bottom  
 H. 11 cm



Decor Tortora  
 /Tortora Decor



Decor Arena  
 /Arena Decor



Eukalipto Cenere  
 /Eukalipto Cenere



Rovere Bruno  
 /Bruno oak



Decor laccati opachi  
 /Matt lacquered Decor

## Accessori per cassetti e vassoi

---

/Accessories for drawers and trays  
/Accesorios para cajones y bandejas  
/Accessoires pour tiroirs et plateaux  
/Zubehör für Schubladen und Ablagen  
/Дополнительные элементы для ящиков и лотков

---

Scatole portaoggetti rivestite in tessuto H 5 cm  
/Fabric-covered storage boxes H. 5 cm



Scatole portaoggetti per cassetto rivestite in tessuto  
/Fabric-covered storage boxes for drawers



Scatole portaoggetti per vassoio estraibile rivestite in tessuto  
/Fabric-covered storage boxes for pull-out trays





## Proposte accessori per cassetti e vassoi

/Examples of accessories for drawers and trays  
/Propuestas de accesorios para cajones y bandejas  
/Propositions d'accessoires pour tiroirs et plateaux  
/Beispiele Zubehör für Schubladen und Ablagen  
/Предложения дополнительных элементов для ящиков и лотков

/technical data



Cassetto con profondità interna 40,7 cm  
/Drawer unit, internal depth 40.7 cm



Vassoio estraibile con profondità interna 38,5 cm  
/Pull-out tray, internal depth 38.5 cm



Cassetto con profondità interna 40,7 cm  
/Drawer unit, internal depth 40.7 cm



Vassoio estraibile con profondità interna 38,5 cm  
/Pull-out tray, internal depth 38.5 cm

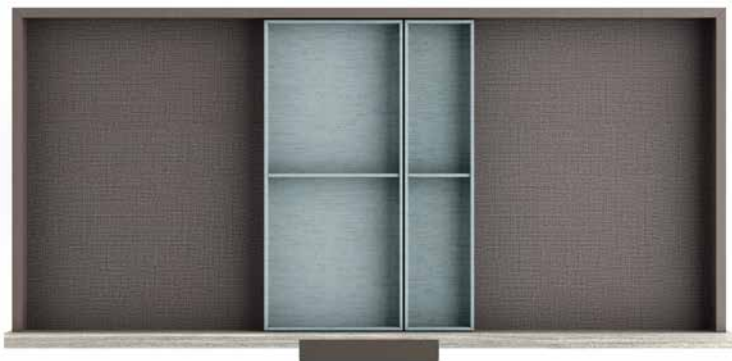

Cassetto con profondità interna 40,7 cm  
/Drawer unit, internal depth 40.7 cm



Vassoio estraibile con profondità interna 38,5 cm  
/Pull-out tray, internal depth 38.5 cm

Alf DaFrè — MIXER

## Elementi sospesi e soluzione portascarpe

/Floating units and shoe-rack solutions

/Elementos suspendidos y zapatero

/Éléments suspendus et solution porte-chaussures

/Hängeelemente und Lösungen für Schuhablagen

/Навесные элементы и подставки для обуви



Portapantaloni in alluminio finitura grigio fumo H 5 cm  
/Aluminium trouser rack in Grigio Fumo finish, H. 5 cm



Portagonna in alluminio finitura grigio fumo H 5 cm  
/Aluminium skirt rack in Grigio Fumo finish, H. 5 cm



Portascarpe in Moka Shine e fondi in finitura  
/Shoe rack in Moka Shine with finished bottom

# Raster

/Cubby-hole unit  
/Raster  
/Raster  
/Raster  
/Растровые конструкции

/technical data



Raster  
/Cubby-hole unit



Raster con scatole rivestite in tessuto  
/Cubby-hole unit with fabric-covered boxes



Scatole con coperchio rivestite in tessuto  
/Fabric-covered boxes with lid

\* Le scatole rivestite in tessuto nei Raster possono essere posizionate solo nei vani centrali  
/The fabric-covered boxes in the cubby-hole units can only be used in the central compartments

Alf DaFrè — MIXER



## Appendieria

---

/Hanging rails  
/Colgador  
/Penderie  
/Kleiderbügel  
/Вешалки

---



Gruccia con portapantaloni L 44 cm in legno Wenghé  
/Hanger with trouser rack L. 44 cm in Wenge wood



Anello portasciarpe Ø 15 cm in legno Wenghé  
/Scarf storage loop, Ø 15 cm, in Wenge wood



Tubo appendiabiti Moka Shine  
/Moka Shine clothes rail



Tubo appendiabiti opzionale Moka Shine con guarnizione  
/Optional Moka Shine clothes rack with seal



Forcella appendiabiti finitura Brown  
/High-reach clothes hook, Brown finish



Servetto oleodinamico finitura Brown  
/Pull-down rail, Brown finish

## Specchi interni

---

/Internal mirrors  
/Espejos internos  
/Miroirs internes  
/Innenspiegel  
/Внутренние зеркала

---

Specchio interno fisso per anta battente  
/Fixed internal mirror for swinging door





## Isola cassetti esterna

/External drawer-unit island  
/Isla externa con cajones  
/Îlot tiroirs externe  
/Insel mit externen Schubladen  
/Внешняя островная конструкция с ящиками

/technical data



Isola cassetti esterna L 110,7 cm  
/External drawer-unit island W 110.7 cm

Isola cassetti esterna L 146,9 cm  
/External drawer-unit island W 146.9 cm



Isola cassetti esterna L 186,9 cm  
/External drawer-unit island W 186.9 cm

Le isole cassetti esterne sono formate da:  
1 vassoio basso con frontale vetro trasparente grigio H 12,4 cm  
1 vassoio alto con frontale vetro trasparente grigio H 18,8 cm  
2 cassetti alto con frontale legno H 18,8 cm  
maniglie finitura Moka shine  
retro a giorno  
/The external drawer-unit islands are composed of:  
1 shallow tray with Grigio transparent glass front, H. 12.4 cm  
1 deep tray with Grigio transparent glass front, H. 18.8 cm  
2 deep drawers with wood front H. 18.8 cm  
handles in Moka Shine finish  
open back

MIXER  
—  
Alf DaFrè

# Moduli

/Units  
/Módulos  
/Modules  
/Module  
/Модули

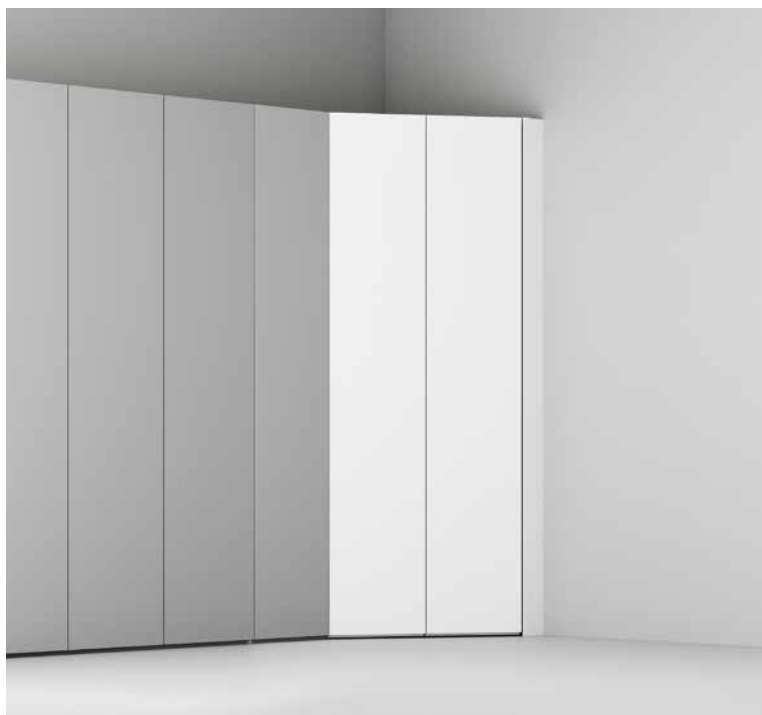

Spogliatoio 2 ante  
/2-door dressing closet

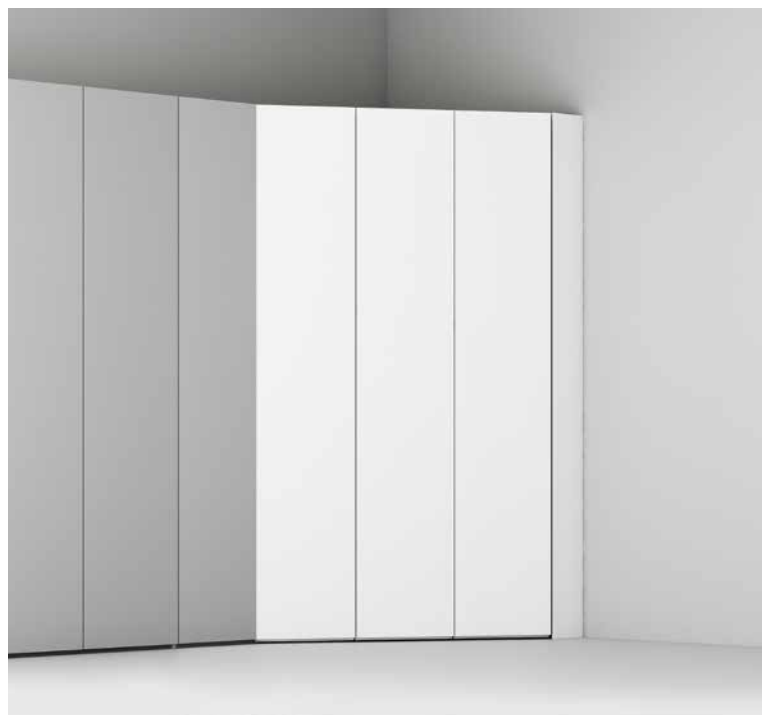

Spogliatoio 3 ante  
/3-door dressing closet

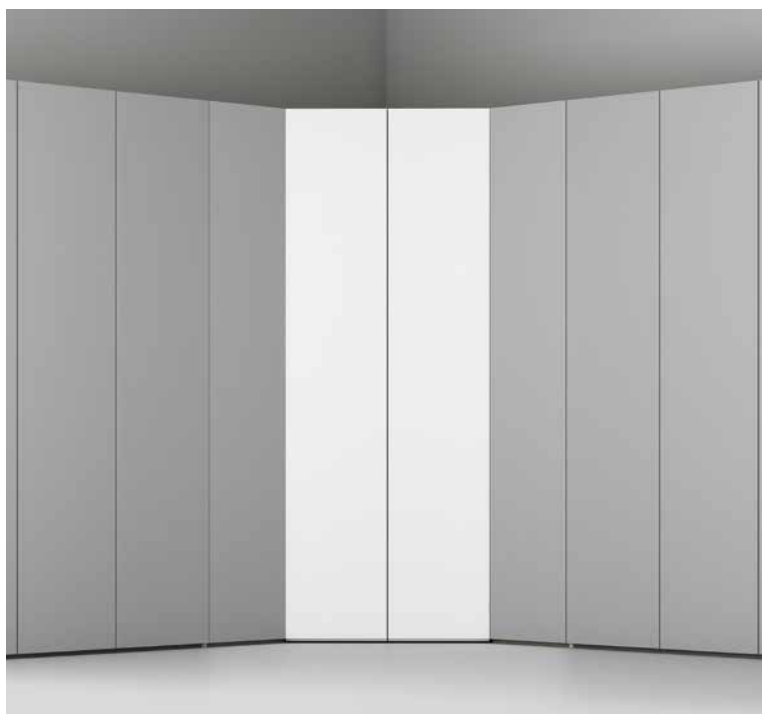

Angolo spogliatoio 2 ante  
/2-door corner dressing closet

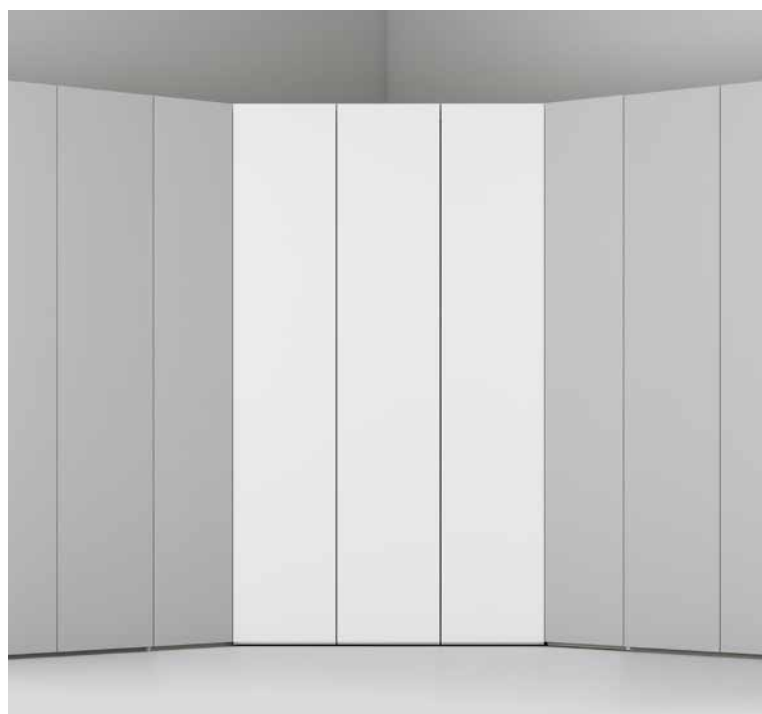

Angolo spogliatoio 3 ante  
/3-door corner dressing closet

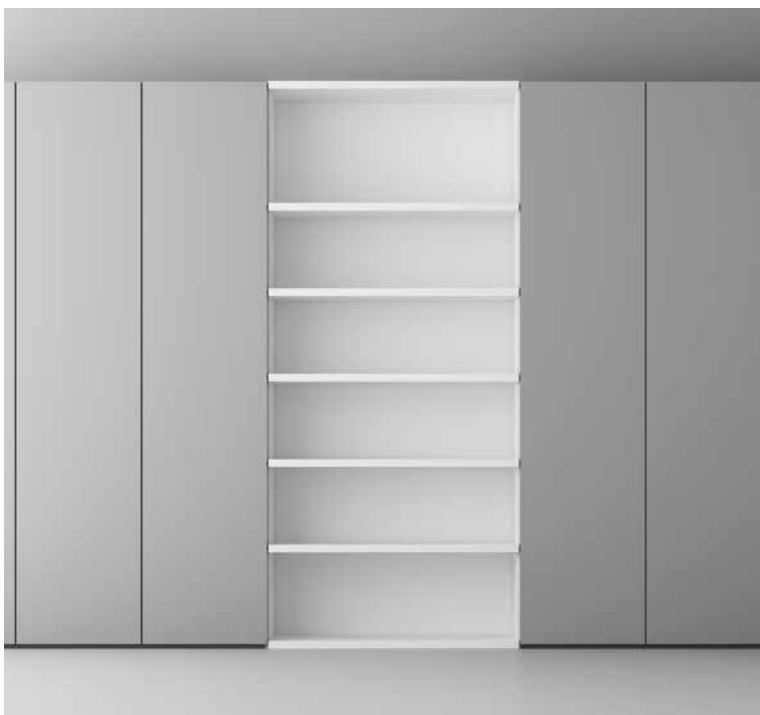

Vano a giorno  
/Open compartment

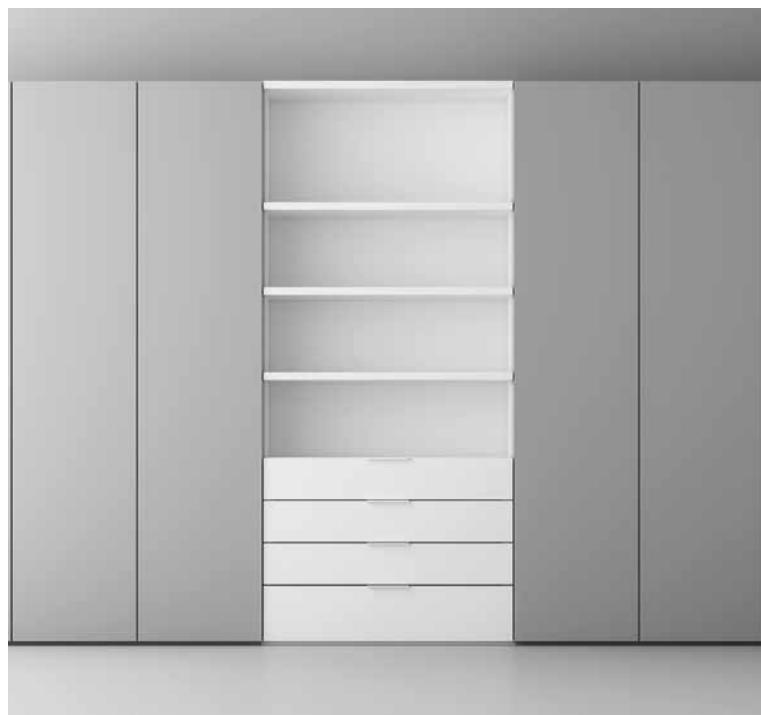

Vano a giorno con cassettera  
/Open-fronted compartment with drawer unit

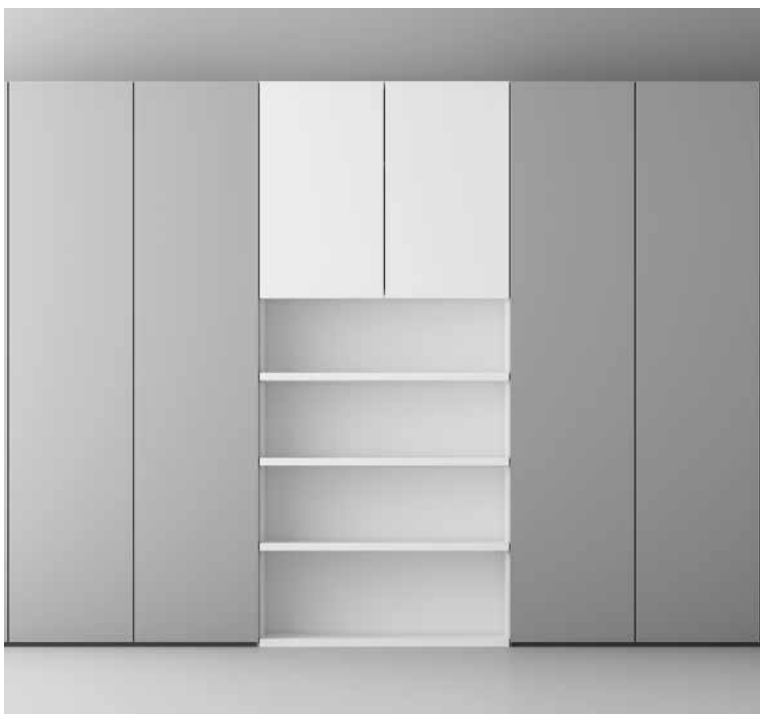

Vano a giorno con anta  
/Open-fronted compartment with door

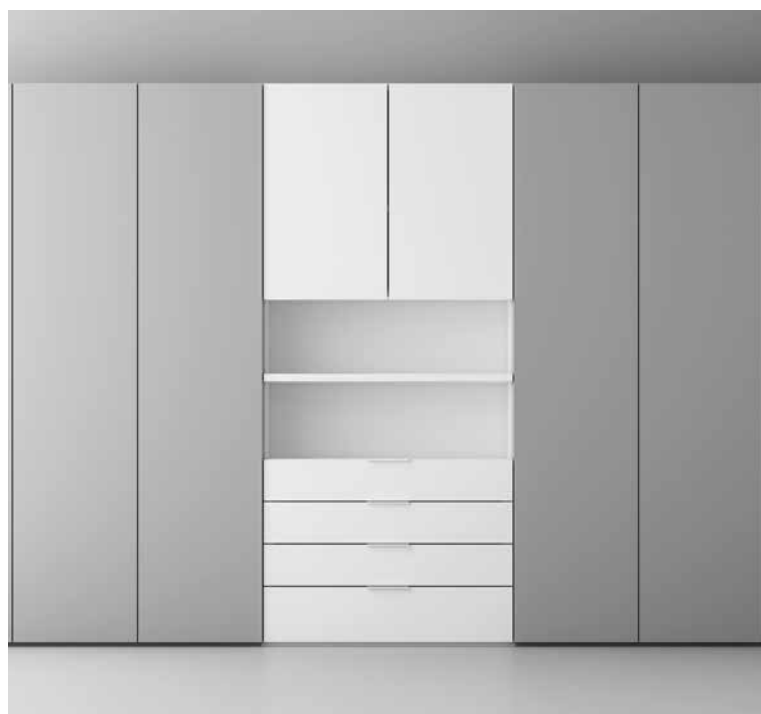

Vano a giorno con cassettera e anta  
/Open-fronted compartment with drawer unit and door



# Moduli

/Units  
/Módulos  
/Modules  
/Module  
/Модули

---



Anta battente  
/Swinging door



Anta scorrevole  
/Sliding door



Anta complanare  
/Coplanar door

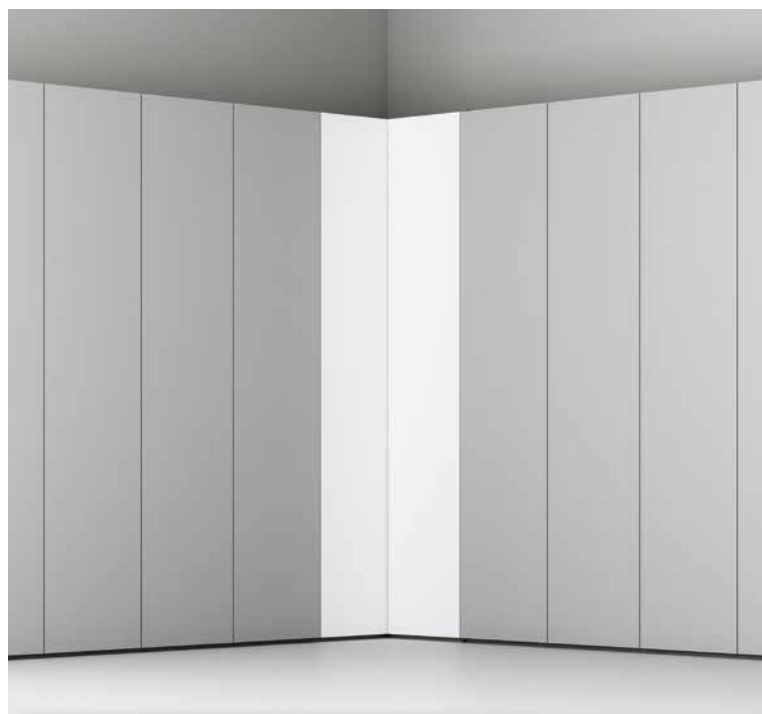

Angolo  
/Corner

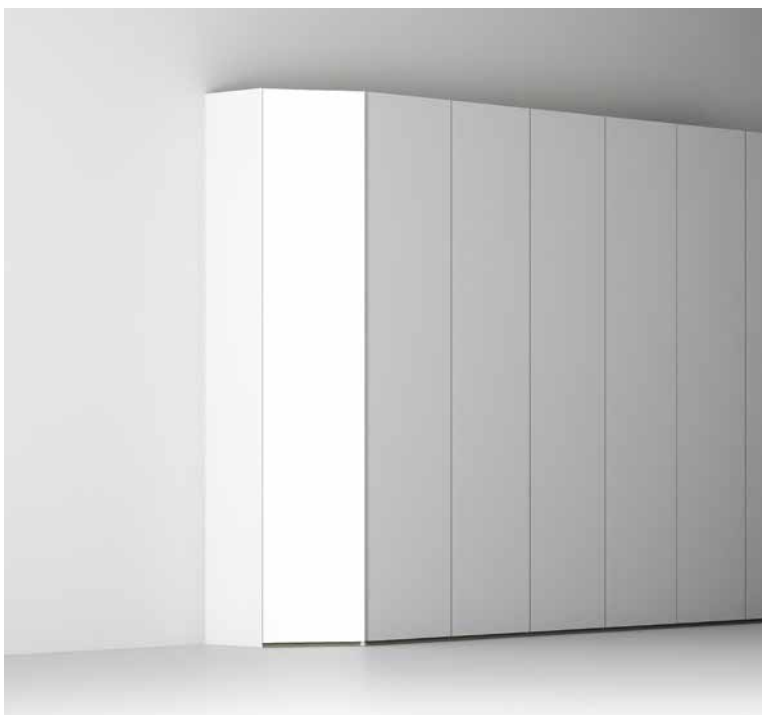

Terminale  
/End unit

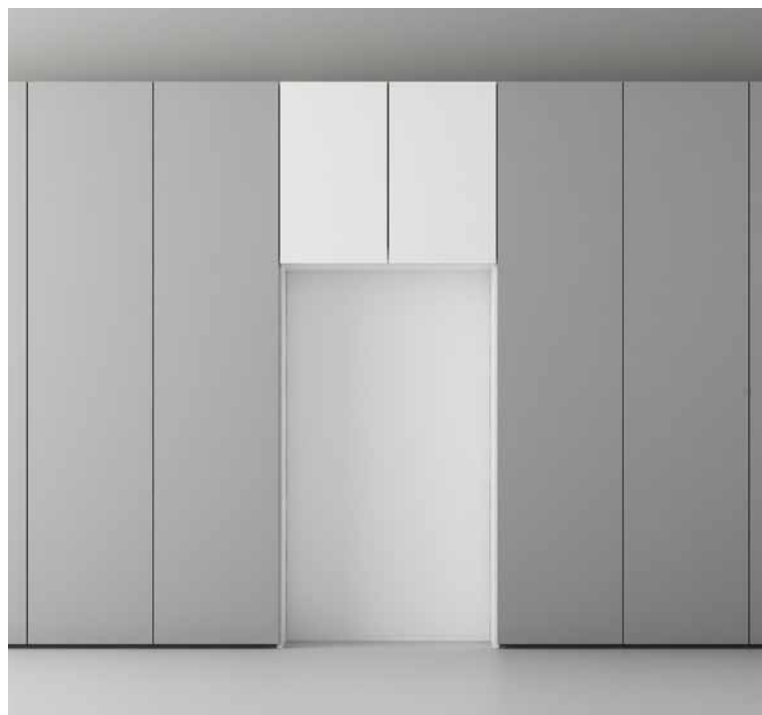

Ponte 2 ante  
/2-door bridge



Ponte 3 ante  
/3-door bridge



Ponte 4 ante  
/4-door bridge

# Moduli

---

/Units  
/Módulos  
/Modules  
/Module  
/Модули

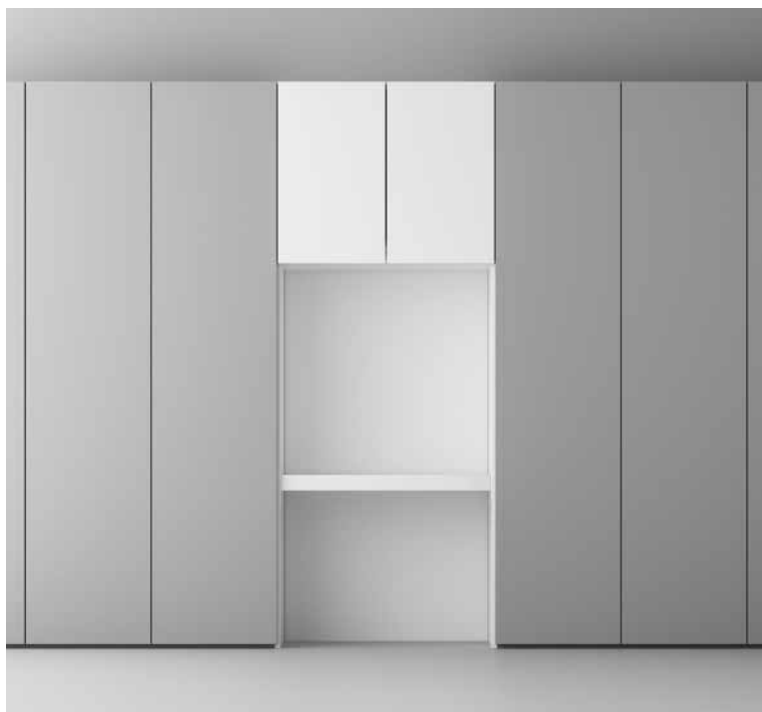

Ponte due ante con scrittoio  
/2-door bridge with desk



Ponte tre ante con scrittoio  
/3-door bridge with desk

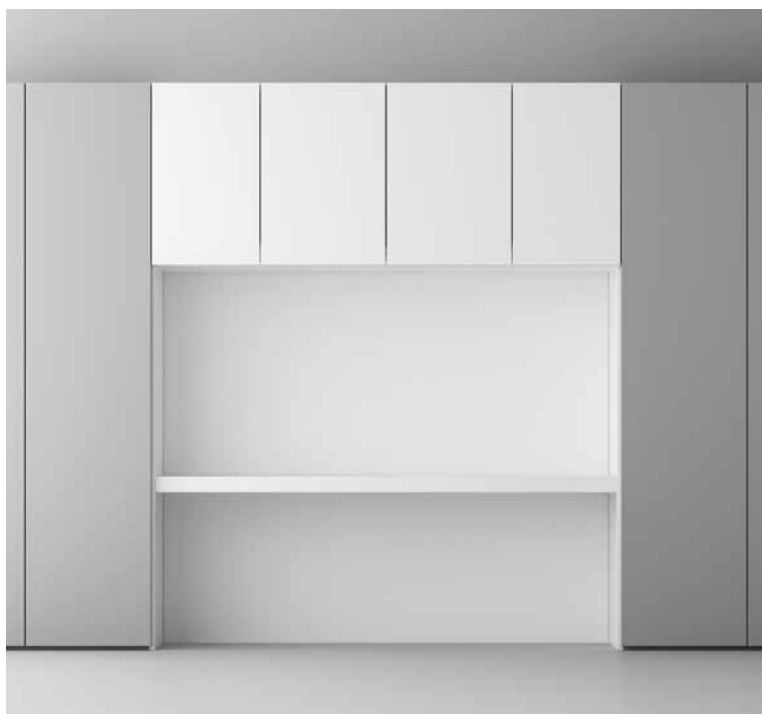

Ponte quattro ante con scrittoio  
/4-door bridge with desk



# Vetri serigrafati anta Frame

/Silk-screen printed glass, Frame door  
/Cristales serografiados puerta Frame  
/Verres sérigraphiés des portes Frame  
/Glas mit Siebdruck Tür Frame  
/Шелкотрафаретные стекла для створки Frame

/technical data



Vetro lucido serigrafato **Sari** /**Sari** high-gloss silk-screened glass

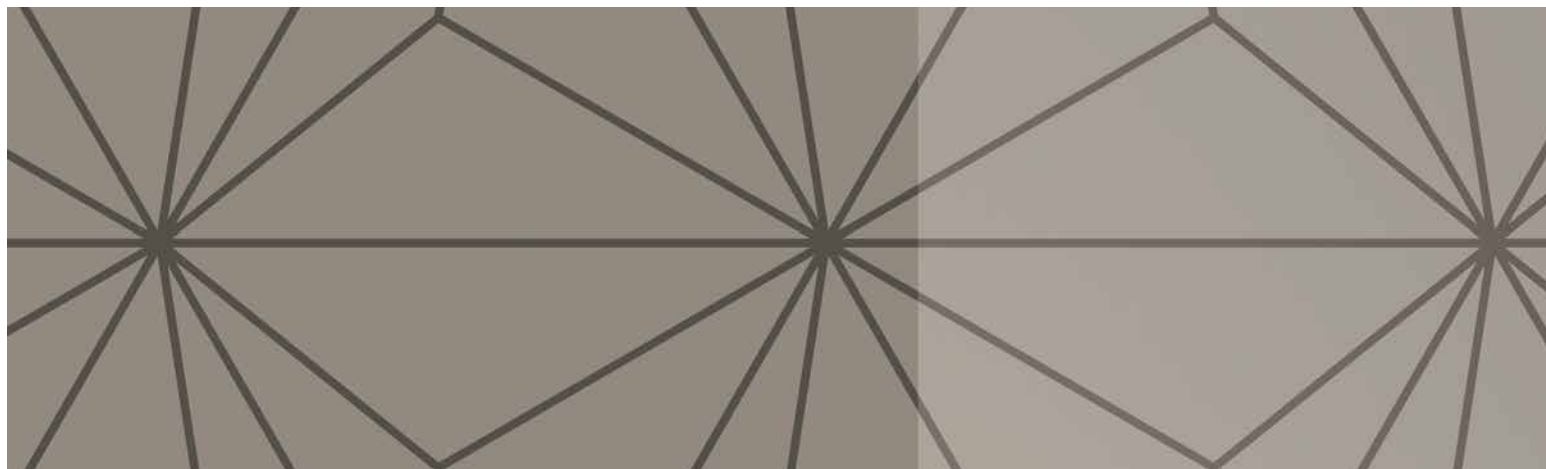

Vetro lucido serigrafato **Asà** /**Asà** high-gloss silk-screened glass

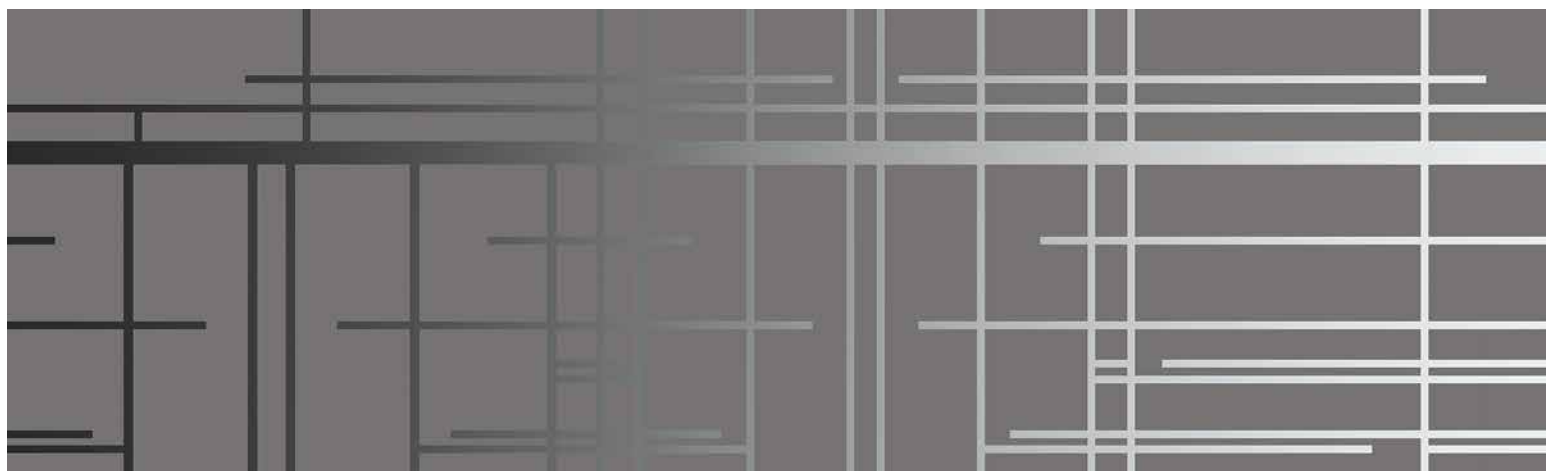

Specchio grigio con serigrafia **Grigio Lino** /Grigio mirror with **Grigio Lino** silk-screen printing

Alf DaFrè — MIXER

